

# Harmony

---

**v\_0.6**

0-Introduction.....	3
1-Harmonics and diatonic scale.....	4
2-Intervals and scales.....	10
3-Building the diatonic scale.....	17
4-Tonality and triads.....	19
5-Minor tonality.....	28
6-Inversions of major and minor triads.....	31
7-Consonance and dissonance.....	33
8-Voice-leading.....	36
9-Voice-leading in minor tonality.....	43
10-Seventh chords.....	45
11-Ninth chords.....	49
12-Embellishing notes and harmonic figuration.....	52
13-Tendency tones and cadences.....	55
14-Modulations.....	59
15-Diminished seventh chord and augmented triad.....	68
16-Chromatic harmony.....	71
Bibliography.....	78

## 0-Introduction

Harmony is the manifestation of notes sounded simultaneously. The theory of harmony comprises the fundamental elements of Western music, especially the common practice period (about 1650-1900).

Music can also exist in the form of a single melody and its rhythmic organization: many musical cultures, such as those of India and China, primarily oriented their developing to the horizontal dimension of the musical sounds, the counterpoint. Counterpoint focuses on the writing of melodies, which have an inner logic in terms of some scales (also called *modes*) out of which they are formed.

During the European Middle Ages and Renaissance, however, the research of conventions and handy rules for writing choral liturgical music led musicians to the idea that melody was only the uppermost layer of a piece of music. By means of uncountable attempts and experiments, the musical scales have been synthesized into a new and profound setup, the tonality. The theory of harmony is based on the concept of tonality, which never stopped to be the central element of the most relevant Western music up to the 20<sup>th</sup> century.

This text will discuss some aspects of the harmony. A primary role will be given to the analysis of the harmonics, or *overtones*, which are involved in the sound produced by all the musical instruments. Their presence is a fundamental aspect of the human perception of the chords and the relationships between them. The examination of the harmonics will provide some explanations to various characteristics of tonal music, such as the minor tonality and the consonance or dissonance of the intervals.

## 1-Harmonics and diatonic scale

Sounds are waves travelling through the air or some other medium. The musical notes, or *tones*, are sounds having one recognizable frequency. The frequency, also called the “pitch”, is the highness of a sound. Technically, the frequency of a wave is the number of oscillations per second performed by the air molecules involved in its (mechanical) propagation, and is measured in Hertz (Hz). The oscillations’ amplitude is related to the volume of the sound, and is measured in decibels (db).

Whereas the noises consist of a casual superposition of sound waves having different frequencies, a traditional musical instrument, except some percussions, is an object that produces a mixture of waves where a frequency which is much louder than the others can be detected: it is the frequency of the note that is sounded by the instrument.

An essential property of many musical instruments (as well as the vocal cords) when sounding a note is the following: in addition to the note’s own frequency, also its multiples have considerable volumes. That is, if an instrument is playing e.g. the note A corresponding to the frequency 110 Hz, then also the frequencies:

$110 \times 2 = 220$  Hz,  $110 \times 3 = 330$  Hz,  $110 \times 4 = 440$  Hz,  $110 \times 5 = 550$  Hz, ...

are particularly emphasized. These frequencies are the **harmonics** or **overtones** of the note that is sounded. The full list, called **harmonic series** or **overtone series**, would be endless, but the volume of the harmonics diminishes (and such decrease doesn’t follow any fixed law) as the frequency increases, so that only the initial harmonics can be detected. Usually the term “harmonics” includes the note itself, which is the 1<sup>st</sup> and loudest harmonic, while the term “overtones” refers to the rest of the harmonics. The 1<sup>st</sup> harmonic is called **fundamental frequency**.

The presence of the harmonics in the musical sounds is related to the mechanical properties of the instruments themselves, which are resonant objects. However, each instrument accentuates some harmonics more than others: that is, whereas the frequencies of the harmonics don’t change if a different instrument is taken, the harmonics’ volumes are a specific aspect of each source of sound. The (infinitely populated) set of harmonics’ volumes of an instrument is called **timbre**. The timbre makes a sound distinctive, so that it’s possible to recognize the particular instrument that is sounding.

The differences between the timbres of different instruments can usually be neglected when writing music: the magnificence of a magnificent piece generally doesn’t depend on the kind of instruments that are sounding. However, since the frequencies of the harmonics are the same for almost all instruments, when putting the notes together for creating chords (a **chord** is a group of more than two notes sounded simultaneously) and melodies, the presence of the harmonics plays an essential role. The musical activities usually focus on the first 10-15 harmonics; in particular, the

initial 6 multiples make the sound of the instruments particularly pleasant, and whenever higher harmonics prevail over them, the notes become harsh and dull.

Among the harmonics of a note, the 2<sup>nd</sup>, 4<sup>th</sup>, 8<sup>th</sup>, 16<sup>th</sup>, ... (the powers of 2) correspond to very special harmonics: they are the **octaves** of the note. The sound produced by a note sounded along with one of its octaves is very distinctive: it's one of the most basic acoustic aspects of music.

Outside the score, the notes are indicated by the seven letters from A to G. The octaves of a note are associated to the same letter. That is, taking e.g. the note C, by multiplying its frequency by 2, 4, 8, 16, ... another C is obtained. The frequency-gap between a note and its first octave (twice the note's frequency) embraces the pitches of all the other notes.

The lowest note that is used in music is the C that corresponds to about 16.35 Hz (hardly hearable by humans). In the American Standard (or Scientific) Pitch Notation, this C is denoted as C0. The octaves of C0 are indicated with C1, C2, C3, ..., that is:

$$C1=C0*2, C2=C0*4, C3=C0*8, C4=C0*16, \dots$$

The octaves of C0 are used as a reference list for naming all the other notes: if the frequency of a note, say G, is found between e.g. C3 and C4, this G will be called G3. This method allows to recognize each G among all its octaves.

All the harmonics of a note, and not only the octaves, can be associated to other notes. Taking e.g. C2 as fundamental frequency, the harmonic series begins with:

$$C2, \mathbf{C3}, G3, \mathbf{C4}, E4, G4, Bb4, \mathbf{C5}, D5, E5, F\#5, G5, Ab5, Bb5, B5, \mathbf{C6}, \dots$$

where the bolded letters mark the octaves of C. This list correspond to the frequencies:

$$65.4, 130.8, 196.2, 261.6, 327.0, 392.4, 457.8, \dots \text{ (Hz)}$$

However, if these frequencies are compared with the above notes sounded on e.g. a traditional piano, it will be possible to observe that, except the octaves, they don't be exactly the same pitch: the harmonics and the piano's notes differ for some amount of Hz. For to assign each harmonic to a note, therefore, some approximation is required. A criterion for establishing these approximations is called **tempered system**. The **equally-tempered system** is by far the most used tempered system in Western music (and also a lot of non-Western music).

The equally-tempered system divides the gap between every note and its first octave into 12 pitches. To each of these 12 pitches corresponds a note, and the closeness of the frequency of a harmonic to one of the pitches allows to assign the corresponding note to this harmonic.

The gap between two consecutive pitches is called **semitone** or **half-step**, so that between a note and its first octave there are 12 semitones. Each semitone is itself subdivided into 100 cents (symbolized with ¢). Two consecutive semitones, i.e. a **whole-step** (200 ¢), are called **tone**. If considering the sequence of 12 consecutive semitones which the octave is subdivided into, then

each semitone increases in frequency by a factor of +1.059 Hz (the twelfth root of 2) with respect to the previous (adjacent) semitone, while the tones increase by a factor of +1.122 Hz (the sixth root of 2).

In figure 1.1 the notes corresponding to the first harmonics of C2 are shown on the score along with their equally-tempered system's approximations (given in cents).

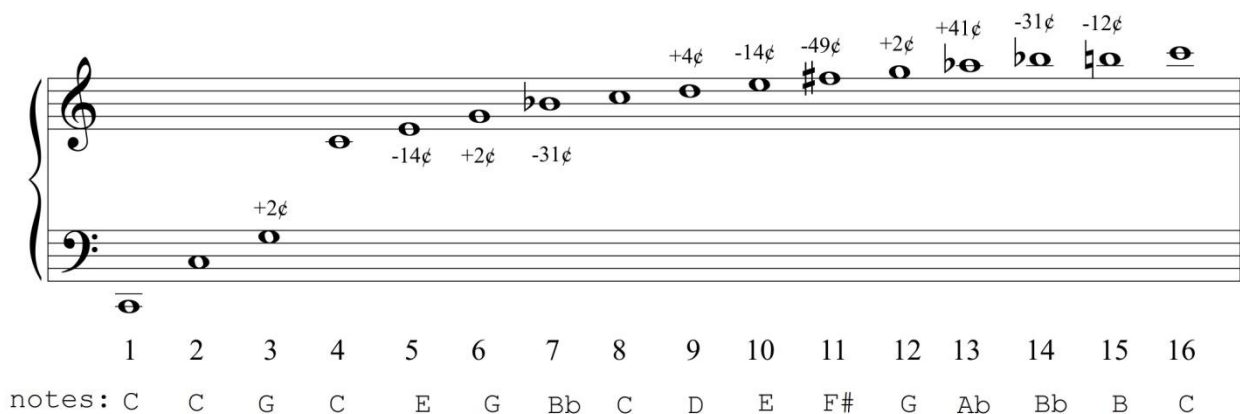

[Figure 1.1: Harmonics of C2 and their equally-tempered system's approximations.]

The difference in pitch between two notes is called **interval**. The tone and the semitone are examples of interval. The most important interval is between a note and its first octave, which is itself called "octave". The octave interval exactly corresponds to the distance between the 1<sup>st</sup> and the 2<sup>nd</sup> harmonics of every note, and also between the 2<sup>nd</sup> and the 4<sup>th</sup>, the 4<sup>th</sup> and the 8<sup>th</sup>, the 8<sup>th</sup> and the 16<sup>th</sup>, and so on (i.e. all the powers of 2).

Furthermore, the interval between the 2<sup>nd</sup> and the 3<sup>rd</sup> harmonics (in the above example, C3-G3) is called "perfect fifth" interval or just "fifth", and the distance between the third and the fourth harmonic (G3-C4) is the "perfect fourth" interval or "fourth". These intervals, the octave, the fifth, and the fourth, occur in the music of almost all cultures. Other common intervals can also be found in the sequence of the harmonics: e.g., the "major third" interval (between the 4<sup>th</sup> and the 5<sup>th</sup> harmonics) and the "minor third" interval (between the 5<sup>th</sup> and the 6<sup>th</sup>).

Since intervals are defined as the "distances" between the harmonics, they don't change when a different fundamental frequency (i.e. the harmonic series of a different note) is considered: an octave always lies between the 1<sup>st</sup> and the 2<sup>nd</sup> harmonics, a perfect fifth always lies between the 2<sup>nd</sup> and the 3<sup>rd</sup>, and so on. That is, every note brings with itself the same sequence of intervals.

Note that if an interval is shifted to a higher or lower pitch, then the frequency-gap it corresponds to doesn't remain the same. E.g., the note C3 (130.8 Hz) is twice the frequency of C2 (65.4 Hz), and C4 (261.6) is twice the frequency of C3: so, the difference in frequency between C2 and C3 is half the difference in frequency between C3 and C4, but an octave interval continues to separate C1 from C2, and C2 from C3. In other words, each octave corresponds to a frequency-gap which is twice the range of the previous octave, and which is half the range of the next.

Since the same interval changes its frequency-range when it is shifted higher or lower, the human brain recognizes the intervals between the notes without knowing the frequencies of the notes. This evaluation is possible thanks to the presence of the harmonics: for example, if the 1<sup>st</sup>, 2<sup>nd</sup>, 3<sup>rd</sup>, 4<sup>th</sup>, ... harmonics of a note respectively coincide with the 2<sup>nd</sup>, 4<sup>th</sup>, 6<sup>th</sup>, 8<sup>th</sup> ... harmonics of another note, then the brain recognizes the octave interval between the two notes. In fact, let's take the harmonic series of C2 and C3:

Harmonics of C2: C2 **C3** G3 **C4** E4 **G4** Bb4 **C5** D5 **E5** F#5 **G5** Ab5 **Bb5** B5 **C6** ...

Harmonics of C3: **C3** **C4** **G4** **C5** **E5** **G5** **Bb5** **C6** ...

The bolded harmonics are coincident. This allow the brain to establish that an octave interval lies between C2 and C3.

The acoustic affinity between a couple of notes separated by a octave is greater than that of any other interval. The next interval to be perceived with great clearness by the brain is the fifth interval. Consider the C2-G2 fifth interval. The involved harmonics are:

Harmonics of C2: C2 C3 **G3** C4 E4 **G4** Bb4 C5 **D5** E5 F#5 **G5** Ab5 ...

Harmonics of G2: G2 **G3** D4 **G4** B4 **D5** F5 **G5** A5 ...

Look at the bolded notes: the 2<sup>nd</sup> harmonic of G coincides with the 3<sup>rd</sup> harmonic of C, the 4<sup>th</sup> harmonic of G coincides with the 6<sup>th</sup> of C, the 6<sup>th</sup> harmonic of G coincides with the 9<sup>th</sup> of C, and so on. Thanks to this very large amount of harmonics that C and G have in common, the brain easily recognizes the fifth interval when these notes (and every other couple of notes a fifth apart) are listened.

Thus, when listening to a piece of music, the brain doesn't consider the pitch of each note: instead, it compares the harmonics of two different notes, and from such comparison it gets the interval they form. Few people, however, have what it's called "perfect pitch" or "absolute pitch": when they listen to a frequency, they can recognize the note corresponding to that frequency.

Before the researches of Helmholtz during the nineteenth century (that led to the publishing of his famous text *Sensations of Tone*), the presence of the harmonics hasn't been completely analyzed and comprehended. However, the harmonics have played a primary role in music since before the birth of harmony, when Western music was entirely based upon systems of scales.

A **scale** is a sequences of notes, arranged in ascending or descending order of pitch, that is used as a collection of sounds for making the melodies. In Western music, the scales generally consist of seven notes and their full length is one octave, so that they can be easily extended over different octaves.

The **diatonic scale** is the most famous seven-notes scale. The diatonic scale that begins on the note C, also called "C diatonic scale", is:

C, D, E, F, G, A, B, (C)

and its notes correspond to the white keys of the piano. In the figure 1.2 these notes are displaced on the score.



[Figure 1.2: The diatonic scale.]

The intervals between E-F and between B-C correspond to a semitone, while the other notes lie a tone distant from the adjacent ones. That is, calling T the tone and S the semitone, the diatonic scale corresponds to the sequence of consecutive intervals T-T-S-T-T-T-S, where the sum of tones and semitones is the amplitude of the octave.

Each note of a scale is called a **degree** of the scale. In the case of the above C diatonic scale, C is the first degree, D is the second, E is the third, and so on. It is therefore a seven-degrees scale.

Although the precise derivation of the diatonic scale from acoustic aspects is matter of discussion (see chapter 3), this scale is strongly related to the perception of the harmonics in the musical sounds: observe that the C diatonic scale includes all the first 10 harmonics of C but Bb.

By switching the positions of the 5 tones and the 2 semitones of the diatonic scale, many different scales can be produced in the range of one octave. In particular, in the European music before the sixteenth-seventeenth centuries, the scales (that were called *modes*) were produced by leaving unaltered the order of the C diatonic scale's tones and semitones, and beginning a new scale from each degree. The result is:

<i>Ionian mode:</i>	C, D, E, F, G, A, B, (C)	(T-T-S-T-T-T-S)
<i>Dorian mode:</i>	D, E, F, G, A, B, C, (D)	(T-S-T-T-T-S-T)
<i>Phrygian mode:</i>	E, F, G, A, B, C, D, (E)	(S-T-T-T-S-T-T)
<i>Lydian mode:</i>	F, G, A, B, C, D, E, (F)	(T-T-T-S-T-T-S)
<i>Mixolydian mode:</i>	G, A, B, C, D, E, F, (G)	(T-T-S-T-T-S-T)
<i>Aeolian mode:</i>	A, B, C, D, E, F, G, (A)	(T-S-T-T-S-T-T)
<i>Hipophrygian mode:</i>	B, C, D, E, F, G, A, (B)	(T-S-T-T-S-T-T)

where the first one (the Ionian mode) coincides with the diatonic scale itself. Although the classification of the modes varies according to the historical period, the above seven scales are known as **diatonic modes** (also "medieval scales", *Gregorian modes* or "church modes").



The diatonic modes have been introduced in the European music by Pope Gregory I (r. 590-604). These scales allowed to collect and organize the body of the liturgical chants in use at the time, and remained the essential theoretical construct until the sixteenth century.

The modes are derived from the old Greek theory, where the seven notes of the diatonic scale could be obtained from the combination of two identical 4-notes scales (tetrachords). In fact, the diatonic scale can be produced by adding together two tetrachords corresponding to the sequence T-T-S of tones, separated by a tone placed in the middle: T-T-S-(T)-T-T-S. As shown above, the modes differ one to each other because they start on different diatonic scale's notes, so that the two semitone intervals are placed in different positions. The interaction between tones and semitones provides a particular mood or feeling to the melodies that are based on each mode.

## 2-Intervals and scales

The diatonic scale beginning with C has the form:

C, D, E, F, G, A, B, (C)

The diatonic scale coincides with the **major scale**. The same seven notes are involved in the **natural minor scale**:

A, B, C, D, E, F, G, (A)

The first degree of these scales, respectively C and A, is called **tonic** or **fundamental tone**. The second degree is called **supertonic**, the third **mediant**, the fourth **subdominant**, the fifth **dominant** and the sixth **submediant**. The seventh degree of the natural minor scale is called **subtonic**, and the seventh degree of the major scale is the **leading-tone**.

The figure shows two musical staves. The top staff is labeled "major scale" and shows the notes C, D, E, F, G, A, B, C on a treble clef staff. Below the notes are labels: Tonic, Supertonic, Mediant, Subdominant, Dominant, Submediant, Leading Tone, Tonic. The bottom staff is labeled "natural minor scale" and shows the notes A, B, C, D, E, F, G, A on a treble clef staff. Below the notes are labels: Tonic, Supertonic, Mediant, Subdominant, Dominant, Submediant, Subtonic, Tonic. Below the two staves, the degrees 1 through 8 are listed.

major scale

natural minor scale

degree: 1 2 3 4 5 6 7 8

[Figure 2.1: C major scale and A natural minor scale.]

The mediant, the submediant and the subtonic degrees of the natural minor scale lie one semitone lower than the mediant, the submediant and the leading-tone of the major scale. The other degrees are coincident, i.e. they form the same intervals with their tonic. In particular, the amplitude of the tonic-mediator interval distinguishes a major scale from a minor scale: whenever it corresponds to 4 semitones, as in the major scale, the scale is a major or "major-like"; if it corresponds to 3 semitones, as in the natural minor scale, then the scale is a minor or "minor-like".

The intervals between the diatonic scale's notes are called *prime*, *second*, *third*, *fourth*, *fifth*, *sixth*, and *seventh* depending on the number of degrees they occupy, including both the notes forming the interval. E.g., the fourth interval D-G occupies 4 degrees: D, E, F, G. The prime interval is the interval between a degree and itself. The intervals between the tonic and the other notes of the diatonic/major scale are shown in Figure 2.2.



[Figure 2.2: Intervals between the diatonic/major scale's degrees and the tonic.]

However, the names "prime", "second", "third", ... are not sufficient for completely characterizing the intervals: e.g., both F-A and E-G are third intervals, since they involve three degrees, but they correspond to a different number of semitones. Therefore, the subdivision of the octave in 12 semitones is needed for properly classifying the intervals. The scale that is produced from the equal-tempered subdivision of the octave in 12 half-steps is called **chromatic scale**:

**C**, C#/Db, **D**, D#/Eb, **E**, **F**, F#/Gb, **G**, G#/Ab, **A**, A#/Bb, **B**, **(C)**

where the bolded letters mark the diatonic scale, and the non-diatonic notes can be written either using a sharp or a flat. To be specific, the ascending form of the scale is written with sharps, and the descending with flats, as shown in Figure 2.3.

Ascending chromatic scale

C C# D D# E F F# G G# A A# B C

Descending chromatic scale

C B B# A A# G G# F E E# D D# C

C#	D#	F#	G#	A#	C#	D#
Db	Eb	Gb	Ab	Bb	Db	Eb
Bx	Fb	Ex	Cb	Bx	Fb	Fb
<b>C</b>	<b>D</b>	<b>E</b>	<b>F</b>	<b>G</b>	<b>A</b>	<b>B</b>
B#	Cx	Dx	E#	Fx	Gx	Ax
Db	Eb	Fb	Gb	Ab	Bb	Cb
<b>C</b>	<b>D</b>	<b>E</b>	<b>F</b>	<b>G</b>	<b>A</b>	<b>B</b>
B#	Cx	Dx	E#	Fx	Gx	Ax
Db	Eb	Fb	Gb	Ab	Bb	Cb

[Figure 2.3: The chromatic scale.]

The chromatic scale allows to transport the intervals higher or lower without changing the number of semitones to which they correspond. E.g., the third interval F-A can be written one semitone higher: F#-A#, or Gb-Bb. In other words, the chromatic scale permits the **transposition**: a group of notes (melodies or chords) is said to be *transposed* when all the notes are written the same interval higher or lower than their original pitch. In particular, the chromatic scale allows to write the diatonic scale at different pitches: after the transposition, some notes will have acquired or lost accidentals for preserving the nature of the diatonic scale.

The presence of 12 notes in the chromatic scale produces 12 intervals (in the range of the octave):

- **unison** (or *prime*) [0 ♢]: the distance between a note and itself.
- **minor second** [100 ♢]: the semitone.
- **major second** [200 ♢]: the tone. E.g., the tonic-supertonic interval in both the major and the natural minor scales.
- **minor third** [300 ♢]: e.g., the tonic-mediant interval in the natural minor scale.

- **major third** [400 ¢]: e.g., the tonic-mediant interval in the major scale.
- **perfect fourth** [500 ¢]: e.g., the tonic-subdominant interval in both the major and the natural minor scales.
- **tritone** [600 ¢]: the interval between the subdominant and the leading-tone in the major scale, or the supertonic-submediant interval in the natural minor scale.
- **perfect fifth** [700 ¢]: e.g., the tonic-dominant interval in both the major and the natural minor scales.
- **minor sixth** [800 ¢]: e.g., the tonic-submediant interval in the natural minor scale.
- **major sixth** [900 ¢]: e.g., the tonic-submediant interval in the major scale.
- **minor seventh** [1000 ¢]: e.g., the tonic-subtonic interval in the natural minor scale.
- **major seventh** [1100 ¢]: e.g., the tonic-leading-tone interval in the major scale.
- **octave** [1200 ¢]: the total length of the scale.

The placing of an accidental against a note of the C diatonic scale produces a **chromatic alteration**. If a sharp is used, the note is said to be **chromatically raised**, if a flat is used, the note is **chromatically lowered**. In both the cases, the note is said to be **chromatically altered**.

By chromatically altering either the upper or the lower note of the above intervals, the following happens:

- If a minor interval is enlarged by chromatically altering one of its notes (i.e., the upper note is chromatically raised, or the lower note is chromatically lowered), then it becomes a major interval. E.g., the minor third E-G becomes either the E-G# or the Eb-G major third.
- If a major interval is reduced by chromatically altering one of its notes, then it becomes a minor interval. E.g., the major sixth C-A becomes either the C#-A or the C-Ab minor sixth.
- If a perfect or a major interval is enlarged by chromatically altering one of its notes, then it is called **augmented interval**. E.g., the perfect fifth D-A becomes either the D-A# or the Db-A augmented fifth; the major third G-B becomes either the G-B# or the Gb-B augmented third.
- If a perfect or a minor interval is reduced by chromatically altering one of its notes, then it is called **diminished interval**. E.g., the perfect fifth D-A becomes either the D#-A or the D-Ab diminished fifth; the minor third A-C becomes either the A#-C or the A-Cb diminished third.

Every interval that includes a chromatically altered note preserves the name (prime, second, third, ...) of the interval without the chromatic alteration. E.g., the interval G-Bb is a minor third, because the involved diatonic degrees are G, A and B; but the interval G-A#, which has the same amplitude of G-Bb, is an augmented second, because the diatonic degrees are G and A.

The same applies to those intervals where both the upper and the lower notes have been chromatically altered: in such a case, a minor interval can become augmented, and a major interval

can become diminished. E.g., transforming the minor sixth A-F into Ab-F# produces an augmented sixth; transforming the major third F-A into F#-Ab produces a diminished third.

The tritone between F and B is the only interval that doesn't need accidentals for being either an augmented fourth (F-B) or a diminished fifth (B-F). Observe that F and B are the only notes of the C diatonic scale which are separated by a tritone interval.

In the Figure 2.4 the full list of the intervals is shown.

	Pure. (perfect)	Major.	Minor.	Augmented.	Diminished.
Primes.	C	C*		C#	
Seconds.	(unison)	C	C	C#	Cb
Thirds.	C	C	C	C#	Cb
Fourths.	C			C#	Cb
Fifths.	C			C#	Cb
Sixths.	C	C	C	C#	Cb
Sevenths.	C	C	C	C#	Cb
Octaves.	C			C#	Cb

[Figure 2.4: All the intervals in the range of the octave.]

It is also to be noted that the augmented and diminished intervals can have the same amplitude of a major, minor or perfect interval: the labels "augmented" and "diminished" only indicate that an interval has been produced by a chromatic alteration (except the special case of the tritones F-B and B-F).

The addition of an octave to the above listed intervals produces the ninth interval (second+octave), the tenth interval (third+octave), the eleventh interval (fourth+octave), and so on. These intervals are very similar to the original ones, since the octave-extension doesn't change their main acoustic qualities. Also their names continue to be major/minor, augmented/diminished or perfect: e.g., C2-E3 is a major tenth, C2-G3 a perfect twelfth, C2-F#3 an augmented eleventh.

Transporting the lower note of an interval to the octave above, as well as transporting the higher note to the octave below, produces an **inversion** of the interval. That is, an inverted interval has its notes interchanged: e.g., G-C is the inversion of C-G. The inversions of all the intervals but the tritone (which divides the octave in two equal parts) have different amplitudes than the original interval. To be specific:

- The inversion of the unison is the octave.
- The inversion of the minor second is the major seventh.
- The inversion of the major second is the minor seventh.
- The inversion of the minor third is the major sixth.
- The inversion of the major third is the minor sixth.
- The inversion of the perfect fourth is the perfect fifth.
- The tritone remains the same. To be specific, the inversion of the augmented fourth is the diminished fifth, and the inversion of the diminished fifth is the augmented fourth.
- The inversion of the perfect fifth is the perfect fourth.
- The inversion of the minor sixth is the major third.
- The inversion of the major sixth is the minor third.
- The inversion of the minor seventh is the major second.
- The inversion of the major seventh is the minor second.
- The inversion of the octave is the unison.

Observe that the inverted major intervals are minor and the inverted minor intervals are major; the inverted diminished intervals are augmented and the inverted augmented intervals are diminished; the inverted perfect intervals remain perfect.

Couples of notes that have some of their initial harmonics in common often form a **consonant interval**. To be specific, in the range of the octave the consonant intervals are:

- Octave and unison
- Perfect fifth
- Perfect fourth (not always)
- Major and minor thirds
- Major and minor sixths

The remaining ones, i.e. the tritone, the (major and minor) seconds and the (major and minor) sevenths are **dissonant intervals**.

By looking at the list of the inversions of the intervals, it can be noted that the inversions of the consonant intervals are consonant, and the inversions of the dissonant intervals are dissonant.

As discussed in chapter 1, the human brain recognizes the intervals by comparing the harmonics of the two involved notes. The consonance or dissonance of an interval is related to the amount of computation that is required by the brain for its identification: as the computation becomes easier, the consonance of the interval becomes greater, and vice-versa. E.g., the octave is the easiest

interval to be recognized because the two notes have exactly the same harmonics, and therefore it is the most consonant interval.

The term “dissonant”, anyway, it’s not related to a bad or fastidious sound: on the contrary, for an interval or a chord to be dissonant means exclusively that it creates tension, that is, it generates in the listener the need for another interval or chord to follow. In chapter 7 the acoustic aspects of the consonance or dissonance of the intervals will be discussed.

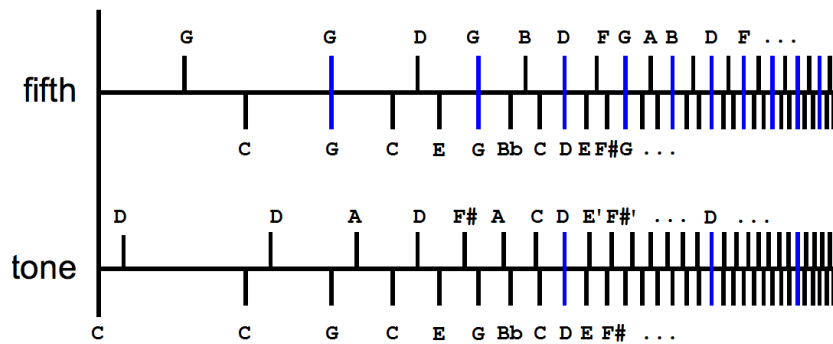

[**Figure 2.5:** Harmonics of two notes a perfect fifth apart (above) compared with the harmonics of two notes a major second apart (below). The blue lines mark the harmonics that the upper and the lower notes have in common. The larger amount of common harmonics gives to the perfect fifth its consonant character; on the contrary, the tone is dissonant.]

Among the consonant intervals, the term “consonant” don’t be totally appropriate in the case of the fourth interval: in fact, when the fourth is placed right above the lowest note of a chord (or when writing for two voices or instruments only), it may sounds dissonant. On the contrary, if the fourth separates two of the upper notes of a chord, it is consonant. This happens because the fourth’s upper note doesn’t belong to the initial harmonics of the lower note.

The diatonic scale involves a great amount of consonant intervals. In fact, there are six fifth intervals (C-G, D-A, E-B, F-C, G-D, A-E), three major thirds (C-E, F-A, G-B), four minor thirds (D-F, E-G, A-C, B-D), and respectively the same number of fourths (the fifth intervals inverted), minor sixths (the major thirds intervals inverted) and major sixths (the minor thirds intervals inverted). In addition, the whole length of the scale is the octave.

All the consonant intervals can be found by looking at the distances between the initial harmonics, as it was anticipated in chapter 1. To be specific, the octave is the distance between the 1<sup>st</sup> and the 2<sup>nd</sup> harmonics, the perfect fifth is the distance between the 2<sup>nd</sup> and the 3<sup>rd</sup>, the perfect fourth between the 3<sup>rd</sup> and the 4<sup>th</sup>, the major third between the 4<sup>th</sup> and the 5<sup>th</sup>, the minor third between the 5<sup>th</sup> and the 6<sup>th</sup>. Moreover, the distance between the 3<sup>rd</sup> and the 5<sup>th</sup> is a major sixth, and the distance between the 5<sup>th</sup> and the 8<sup>th</sup> is a minor sixth.

Consequently, it is common to identify the intervals, instead of taking a couple of notes, by specifying the corresponding distance between the harmonics. To be specific, being multiples of

the fundamental frequency, the harmonics have the property that the 1<sup>st</sup> harmonic is half the frequency of the 2<sup>nd</sup>, the 2<sup>nd</sup> is 2/3 the frequency of the 3<sup>rd</sup>, the 3<sup>rd</sup> is 3/4 the frequency of the 4<sup>th</sup>, and so on. This relationship can be used for calling the intervals by their **frequency ratio**: the interval between the 1<sup>st</sup> and the 2<sup>nd</sup> harmonics (the octave) corresponds to the 1:2 ratio, the interval between the 2<sup>nd</sup> and the 3<sup>rd</sup> harmonics (the fifth) corresponds to the 2:3 ratio, and so on. In general, the interval between the harmonic number  $n$  and the harmonic number  $m$  corresponds to the frequency ratio  $n:m$ .



### 3-Building the diatonic scale

The music of almost every culture has evolved around particular scales. The shape of the scales has been influenced by uncountable factors, such as the human perception of the involved intervals and the technological advancement of the adopted instruments. Thus, since a scale is the result of some human-dependent aesthetic and historical development, a purely acoustic analysis cannot completely explain its origins.

However, the acoustic phenomena being involved in the particular form of a scale contribute in justifying some aspects of the music that is produced by adopting such scale. These acoustic phenomena are related to the brain's capability of computing the relationships between the scale's notes, and thus they can clarify part of the processes that led to the preference of a scale over its variants that have appeared in the history and then have become obsolete.

The procedure which is usually adopted in the derivation of a scale consists of considering some of its degrees and then, by looking at their first harmonics, to justify the presence of the other degrees. In addition to the harmonics, also the harmonics of the harmonics, called **secondary harmonics**, are taken into consideration. For being distinguished from the secondary harmonics, the firsts are also called *primary harmonics* or *generators*.

A frequently adopted derivation of the diatonic scale consists of considering the harmonics of the tonic, the dominant and the subdominant degrees. That is, in the case of the C diatonic scale, the notes C, G and F. Observe that G, the 3<sup>rd</sup> harmonic of C, brings the strongest contribution to the sound of C because it is the first harmonic of C that is different from the octaves. Therefore, its harmonics are the most significant secondary harmonics in the sound of C. The other degrees of the diatonic scale are taken from the harmonics of F.

Thus, consider the first 5 harmonics of C, G and F:

C, C, G, C, E, ...

G, G, D, G, B, ...

F, F, C, F, A, ...

All the diatonic notes are present. So we have:

- Tonic
- Supertonic: 3<sup>rd</sup> harmonic of the dominant
- Mediant: 5<sup>th</sup> harmonic of the tonic
- Subdominant
- Dominant
- Submediant: 5<sup>th</sup> harmonic of the subdominant
- Leading-tone: 5<sup>th</sup> harmonic of the dominant

Some authors justify the diatonic scale by considering, in place of the subdominant, the supertonic degree (in the C diatonic scale, the note D). With such selection, the diatonic scale is derived as follows:

- Tonic
- Supertonic
- Mediant: 5<sup>th</sup> harmonic of the tonic
- Subdominant: 7<sup>th</sup> harmonic of the dominant
- Dominant
- Submediant: 3<sup>rd</sup> harmonic of the supertonic
- Leading-tone: 5<sup>th</sup> harmonic of the dominant

## 4-Tonality and triads

The ability of the human brain to identify the intervals between the notes is an essential aspect of the perception of the music. As noted in chapter 1, the brain doesn't have the capacity to recognize a note when hearing its frequency (except for the people that have the absolute pitch), but it is able to detect the interval between two notes through the comparison of their harmonics. If the brain perceives that the 1<sup>st</sup>, 2<sup>nd</sup>, 3<sup>rd</sup>, ... harmonics of a note coincide with the 2<sup>nd</sup>, 4<sup>th</sup>, 6<sup>th</sup>, ... harmonics of a second note, it recognizes the octave interval. If the brain perceives that the 2<sup>nd</sup>, 4<sup>th</sup>, 6<sup>th</sup>, ... harmonics of a note coincide with the 3<sup>rd</sup>, 6<sup>th</sup>, 9<sup>th</sup>, ... harmonics of a second note, it recognizes the perfect fifth interval.

The octave and the fifth require the smallest amount of computation for being identified, and therefore are perceived as the most consonant intervals. Vice-versa, when the brain finds a little quantity of coincident harmonics its elaboration becomes more difficult, and the effect of dissonance is produced. E.g., in the case of the tone interval, only the 8<sup>th</sup>, 16<sup>th</sup>, 24<sup>th</sup>... harmonics of the upper note coincide with the 9<sup>th</sup>, 18<sup>th</sup>, 27<sup>th</sup> ... harmonics of the lower note.

Moreover, if the fundamental frequency is artificially subtracted from the harmonics of a note, it has been shown that the listener will continue to detect the same note, that is, he will continue to hear the non-existing 1<sup>st</sup> harmonic. The brain processes the other harmonics, and spontaneously calculates the fundamental frequency. This phenomenon is called **virtual pitch**, and it is used in engineering e.g. when the speakers are too physically small to produce the lowest notes: instead they play only their harmonics, and rely on the brain's computation to reconstruct the note.

This suggests that, when a melody or a chord adopts notes that coincide with the harmonics of some fundamental frequency (or with its secondary harmonics), such fundamental frequency is to some extent required by the listener. Under the light of the virtual pitch, the acoustic affinity of the major or minor scale's tonic with the other scale's degrees contributes to recognize the tonic as fundamental frequency, and to perceive the other notes in their relation with it. Consequently, during the time in which a melody or a chord doesn't involve the tonic, a more or less strong sense of instability and tension is produced. Then, when the tonic is finally sounded, it is felt as a resting point and provides a pleasant sense of conclusion.

In other words, the tonic pulls toward itself all the other scale's notes: this is the concept of **tonality**. The tonality is the relationship between all the notes of a piece of music and one particular note: the tonic of the major or minor scale which is used. This relationship is established by the harmonics (and secondary harmonics) that the tonic has in common with the other degrees of its scale.

A tonality is called **major tonality** (also **major key** or **major mode**) if the major scale is adopted, that is, the major scale's tonic it is felt as a resting point; and it's called **minor tonality** (**minor key**, or **minor mode**) if the natural minor scale (and its two variants, as discussed in the next chapter) is adopted, that is, the natural minor scale's tonic it is felt as a resting point. Since the notes of the

major and the natural minor scales are the same, the establishment of either a major or a minor tonality requires that the primary role of the corresponding tonic degree is emphasized by the composer. The tonic of the major or minor scale is also called *tonic of the key* or *root of the key*. The **tonal music** consists of the music where a major or minor tonality is recognizable.

A displacement of three notes whose relative distance is a major or minor third interval is called **triad**. From this definition, it follows that four types of triad are possible:

- The **major triad**, where a major third lies between the lowest note and the middle note, and a minor third is between the middle and the upper note. E.g., C-E-G is a major triad.
- The **minor triad**, where a minor third lies between the lowest note and the middle note, and a major third is between the middle and the upper note. E.g., C-Eb-G is a minor triad.
- The **diminished triad** is made up by adding two minor thirds. E.g., C-Eb-Gb is a diminished triad.
- The **augmented triad** is made up by adding two major thirds. E.g., C-E-G# is an augmented triad.

The lowest note (the bass) of these triads is called the **root**. The middle note is called "third" of triad and the upper note is the "fifth", because they respectively form a third interval and a fifth interval with the root. The four types of triad are shown in Figure 4.1.

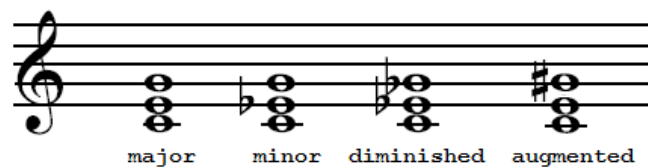

[Figure 4.1: The four types of triad.]

When the root of a major triad is the tonic of the major scale, and when the root of a minor triad is the tonic of the natural minor scale, the triad is called **tonic triad**. E.g., the tonic triad of the C major tonality (where the tonic is the note C) is the major triad C-E-G, and the tonic triad of the A minor tonality (where the tonic is the note A) is the minor triad A-C-E.

For establishing the tonality in piece of music, the tonic triad is the most important chord that has to be used. It is the sound that the listener recognizes as the main point of arrival - where the musical phrases should end: this triad provides a sense of conclusion and relaxation every time the music returns to it. As a consequence, it is very frequent to have the tonic triad at the beginning and at the end of a piece of music.

The root is the most important element of a major or a minor triad. In fact, consider the major triad: this chord has a pleasant sound because the third and the fifth coincide with the two most important harmonics of the root (excluding the octaves). Take e.g. the C-E-G major triad: the third

(E) and the fifth (G) correspond to the first two harmonics of the root C that don't be another C. In other words, the major triad omits the more distant harmonics of its root and reinforces the more immediate; it can be considered the ambassador of the sound of its root. Also the minor triad has analogous properties (even though its third fails to be one of the root's initial harmonics), as will be discussed in the next chapter.

In general, the term **root of a chord** indicates the harmonic series which is predominant in the sound of the chord. If more than one harmonic series play a significant role in the chord's sound, the chord can be said to have **multiple roots**. Furthermore, the root doesn't have to necessary be a note of the chord: e.g., in the chord E-G-Bb-D the harmonic series of C is clearly predominant because all the notes are C's harmonics, but the root C doesn't be part of the chord.

The identification of the root(s) of a chord is of crucial importance when the chord is connected to the previous and the following ones in a piece of music. The connection between a chord and a different chord having the same root(s) sounds generally well.

The lowest note of a interval or chord always assumes (to some extent) the function of root because, since the brain spontaneously searches for harmonic series in the sounds that are listened, it has the tendency to identify the lowest note as the first harmonic of a harmonic series. Thus, the lowest note has a great influence on the whole sound of a interval or a chord: consider that, since all the other notes lie above it in the sound spectrum, they stay in the middle of the lowest note's harmonics. Hence, the higher notes create "secondary intervals" with the harmonics of the lowest note: they have to justify their presence above the lowest note, they are forced to be in relation with it. In general, the pleasantness or solidity of the chords depends on the affinity of the higher notes with those lying below them: the lower notes influence the upper notes by forcing them to cohabit with their harmonics (this is simply the fact that the harmonics are higher than the note that spreads them, hence they can only be in relationship with higher notes).

So, the chord E-G-Bb-D has at least two roots: the note C, because of the presence of its harmonics, and the note E, which is the lowest note. Also, the harmonic series of G appears here (the notes G and D), therefore G could be considered another possible root. In particular, E influences the perception of G, Bb and D; G influences the perception of Bb and D; Bb influences the perception of D; and D is the least important note from the point of view of the harmony, but it is the note which is best distinguished by the listener (because of its highest pitch) and takes part to the melody.

These facts lead to the identification of two levels of perception of the music:

- The "surface level", i.e. the succession of the higher notes of a sequence of chords, which usually coincides with the leading melody of a piece of music.
- The harmonic level, which is the progression of the underlying chords and all the involved harmonic series. That is, the succession of the chords' roots. The harmonic level has a strong influence on the perception of the melody.

The scientific literature offers various procedures and models for computing, for each of the chord's detectable virtual pitches (i.e. for each of the chord's roots), a degree of acoustic affinity with the sound (the harmonics spectrum) of the chord. These methods allow to establish an order of importance among the possible roots of a given chord. Noteworthy examples are the Hofmann-Engl's virtual pitch model, first introduced in 1990, and the earlier Terhardt's algorithm (1977, 1979). Both are Based on the concept of *residual pitch* as introduced by Schouten in 1940.

As a consequence of the behavior of the human mechanism for the detection of harmonic series, when the ear is listening to an interval, it weakly perceives some additional notes, called **combinational tones**. The first combinational tone's frequency is the difference between the frequency of the interval's notes; the frequencies of the subsequent combinational tones (almost totally inaudible) correspond to the difference between the frequency of the harmonics of the interval's notes. The combinational tones actually don't exist in the interval's sound: they are artificially produced by the sophisticated mechanical apparatus of the ear. The nature has built the human ear to be able to detect harmonic series, and the perception of combinational tones follows from this fact: since the harmonics are multiples of the fundamental frequency, the difference between the frequency of two harmonics is the frequency of another harmonic. E.g., the difference between the frequency of the 8<sup>th</sup> and the 5<sup>th</sup> harmonics is the frequency of the  $8-5=3^{\text{rd}}$  harmonic: thus, when listening to the E-C interval (the 5<sup>th</sup> and 8<sup>th</sup> harmonics of C), a lower G is weakly listened with them. So, the ear's production of combinational tones helps the brain to detect harmonic series.

In the music of the common practice period, a large amount of chords are either major or minor triads, or can be interpreted as such. In particular, each degree of the diatonic scale can become the root (the lowest note) of either a major, a minor or a diminished triad whose third and fifth correspond to two of the other diatonic degrees. To be explicit, let's consider the case of C major tonality. All the triads that can be produced by using the 7 notes of the C diatonic scale are the following:

**C-E-G ; D-F-A ; E-G-B ; F-A-C ; G-B-D ; A-C-E ; B-D-F**

These chords are known as **diatonic triads**. The triads C-E-G, F-A-C and G-B-D are major triads; D-F-A, E-G-B and A-C-E are minor triads; and B-D-F is a diminished triad. These triads also belong to the A minor tonality, since the diatonic scale is the same.



[Figure 4.2: The diatonic triads.]

Triads can appear in different forms. In fact, by transporting the third, or both the two upper notes, to an octave higher, then the triad's acoustic features and qualities don't change. Also, by

duplicating any of its notes (more often the bass or the perfect fifth) onto the octaves above, the nature of the chord remains the same: it is in fact the ordinary practice when writing for more than three elements. In all these cases, the root remains the lowest note.

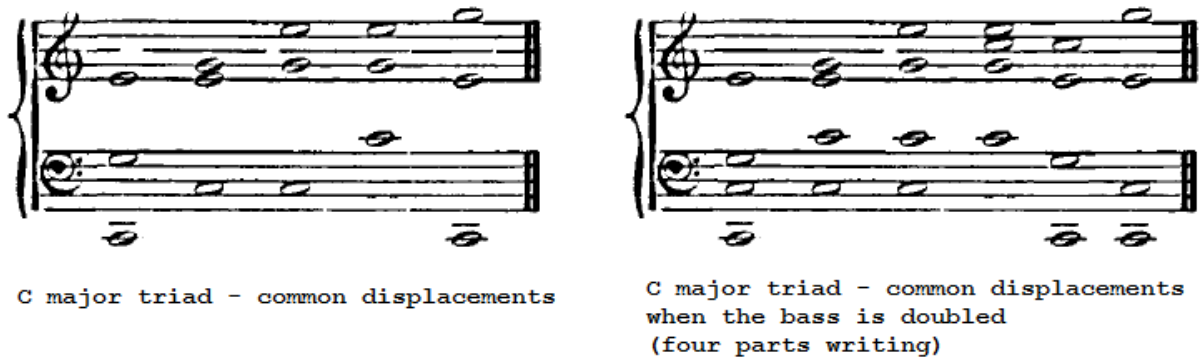

[Figure 4.3: Examples of C major triad's displacement in three and four parts writing.]

In the Figure 4.3 some common solutions for placing the C major triad on the grand staff are shown, both in the case of three and four parts writing (in this case, the bass has been doubled). Not all the other possible displacements are equally good, as it will be discussed in chapter 8.

If the displacement of the triad's notes is altered so that the root doesn't be the bass, quite different chords arise: they are called **triad inversions**, because they involve the inversions of the intervals that the third and the fifth form with the root. To be specific, triads have 2 inversions (shown in Figure 4.4):

- The chord which is obtained by putting the root on the octave above (or by putting the two upper notes on the octave below) is called **first inversion**. E.g., the first inversion of C-E-G is E-G-C, where the bass is E.
- The chord which is obtained by putting the two lower notes on the octave above (or by putting the fifth on the octave below) is called **second inversion**. E.g., the second inversion of C-E-G is G-C-E, where the bass is G.

Thus, the first inversion places the third in the bass, the second inversion does the same with the fifth. Observe that the inversion of an augmented triad produces another augmented triad.

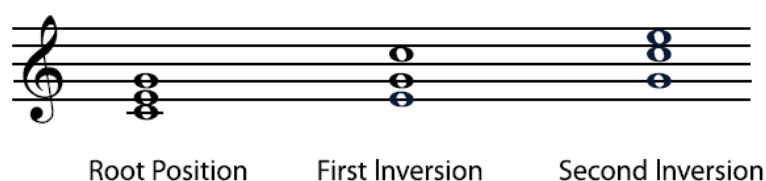

[Figure 4.4: Inversions of the C major triad.]

The first inversion of a triad is also known as *sixth chord*, or *chord of the third and sixth*, because the distances between the bass and the other two notes are respectively a third and a sixth interval. Similarly, the second inversion is called *six-four chord*, or *chord of the fourth and sixth*, because a fourth and a sixth intervals are formed with the bass.

Since the inversions don't change the consonant/dissonant character of the intervals, chords are very often replaced with their inversions. However, since the two upper notes of the inversions of the major and the minor triads fail to be harmonics of the new lowest note, these inversions sound weaker and less incisive, and so they are seldom used for concluding the musical phrases. If a triad doesn't be inverted, is said to be in **root position**, because the root is the bass. When speaking of "C major triad" or "C minor triad", the letter "C" always refers to the root of the triad, even if the triad is written in inversion.

It is frequent to indicate the triads by adopting the Roman numerals I, II, III, IV, V, VI, VII: these numerals specify the degree of the major or minor scale upon which a triad is built (i.e. they indicate the root). For example, in C major, I is C-E-G; in A minor, I is A-C-E. The connection from e.g. V to I is written V-I. There are different styles for writing the numerals: writers in German use upper-case letters, writers in English often adopt upper-case letters for major and augmented triads, and lower-case letters for minor and diminished triads. Moreover, there is a quantity of additional signs for indicating e.g. if the triad is in root position or in inversion, if additional notes are placed, if the triad is subjected to chromatic alterations, and so on. This text will use only the upper-case Roman numerals.

As noted above, when listening to the dominant degree the brain recognizes the 3<sup>rd</sup> harmonic of the tonic: in particular, the brain perceives that the harmonics of the dominant are secondary harmonics of the tonic. As a consequence, it is possible to identify in the dominant degree a significant predisposition to move toward the tonic. Similarly, it is possible to identify in the major triad whose root is the dominant degree a significant predisposition to move toward the tonic triad. The major triad whose root is the dominant degree is called **dominant triad**. Using Roman numerals, the dominant triad is V. Thus, the major dominant triad provides the most incisive connection to the tonic triad I (i.e. V-I). This progression, V-I, reinforces the listener's perception of I as the tonic triad, and therefore it clearly establishes the tonality which is adopted.

Any note behaves to some extent like a dominant degree, since any note can always be thought as the fifth above a tonic, i.e. its harmonics can always be considered secondary harmonics. Thus, any note has the tendency to move a fifth interval below it, and this tendency affects the entire chords as well: any chord would spontaneously move a fifth interval below its root. That is, the **root-motion of descending fifth** is the most natural destination of any chord. Whenever more than one root can be assigned to a chord, there are more than one destinations: each of the harmonic series that the brain perceives in the sound of the chord brings with itself the tendency to move to the harmonic series lying a fifth below it. E.g., consider the diminished triad E-G-Bb. Two roots can be identified in this chord: the lowest note E, and C, because E, G and Bb are harmonics of C. Therefore, there are two possible root-motions of descending fifth: the motion toward the chords



having A as a possible root (since E is the fifth of A), and the motion toward the chords where F is a possible root (since C is the fifth of F).

A change of the tonality in the middle of a piece is called a **modulation**. The modulations, that will be discussed in chapter 14, are of very frequent usage in the common practice music, especially the Romantic period. Since a change of the tonality corresponds to the adoption of a different diatonic scale, a different key signature is required.

The key signature includes the accidentals that are incorporated in the diatonic scale that is used. The couples of major and minor tonalities that have in common the same diatonic scale, therefore, have identical key signatures, and the minor tonality is called **relative minor** of the major tonality. Vice-versa, the major tonality is called **relative major** of the minor tonality. By looking at the key signature, consequently, it's impossible to understand if either a major or minor tonality is used, and the examination of the score is needed.

The couples of major and minor keys that have the same tonic, such as C major and C minor, are called **parallel major** and **parallel minor** (and their key signatures differ in three notes). So, C major is the parallel major of C minor, and vice-versa.

In view of the fact that the C diatonic scale doesn't have accidentals, no accidentals are written in the key signature of C major and A minor tonalities. The key signature of the other tonalities is obtained by transposing the C diatonic scale higher or lower. Since there are 12 semitones in one octave, 12 transpositions are possible. Since each diatonic scale provides two tonalities, 24 tonalities are available.

E.g., the G major key (and its relative minor, the E minor key) has one accidental, F#, in its key signature, because in the diatonic scale that begins on G:

G, A, B, C, D, E, F#

a sharp on the seventh degree is present to obtain the leading-tone. Similarly, the transposition of the C diatonic scale to F produces:

F, G, A, Bb, C, D, E

where Bb allows to obtain the diatonic's fourth degree. Consequently, F major and D minor have Bb in the key signature.

The transposition to the remaining diatonic degrees, D, E, A, and B, follows in analogous manner (as the reader can check, they all involve only sharps). In the case of transposition to the non-diatonic degrees of the chromatic scale, the diatonic scale can be written either using sharps (and, eventually, double-sharps) or flats (or double-flats). E.g., the diatonic scale of Db major (Bb minor) is:

Db, Eb, F, Gb, Ab, Bb, C

and the diatonic scale of C# major (A# minor) is:

C#, D#, E#, F#, G#, A#, B#

In the choice between C# and Db, D# and Eb, F# and Gb, G# and Ab, A# and Bb, the smaller number of accidentals which are produced in the transposition leads to prefer Db over C#, Eb over F#, Ab over G# and Bb over A#.

From the transposition of the diatonic scale, a general criterion can be recognized: taking the C diatonic scale as the starting point, the key signature acquires a sharp when transposing to the fifths above (G, D, A, E, B, F#) and acquires a flat when transposing the fifths below (F, Bb, Eb, Ab, Db, Gb). That is:

- The transposition to the fifth above C major (G major) produces F#, and all the other keys involving sharps also have F# in the key signature. The transposition to the fifth above G major (D major) produces, in addition to F#, the note C#, and all the remaining keys involving sharps also have both F# and C#. And so on.
- The transposition to the fifth below C major (F major) produces Bb, and all the other keys involving flats also have Bb in the key signature. The transposition to the fifth below F major (Bb major) produces, in addition to Bb, the note Eb, and all the remaining keys involving flats also have both Bb and Eb. And so on.

Therefore, while varying in number for differentiating the key signature, the accidentals follow a fixed sequence in their coming out. In the case of the sharps, the sequence is: F#, C#, G#, D#, A#, E#, B#. If a tonality includes e.g. A#, then all the preceding sharps in the list (F#, C#, G#, D#) are also present in its key signature. The same applies to the flats, but the order of appearance is reversed, that is, they follow the opposite sequence: Bb, Eb, Ab, Db, Gb, Cb, Fb. If a tonality includes e.g. Gb, then all the preceding flats in the list (Bb, Eb, Ab, Db) are also present in its key signature.

The keys that don't involve double-sharps and double-flats (i.e., the most frequently used ones) can be displaced in a circular relationship, called **circle of the fifths**, which is shown in Figure 4.5.

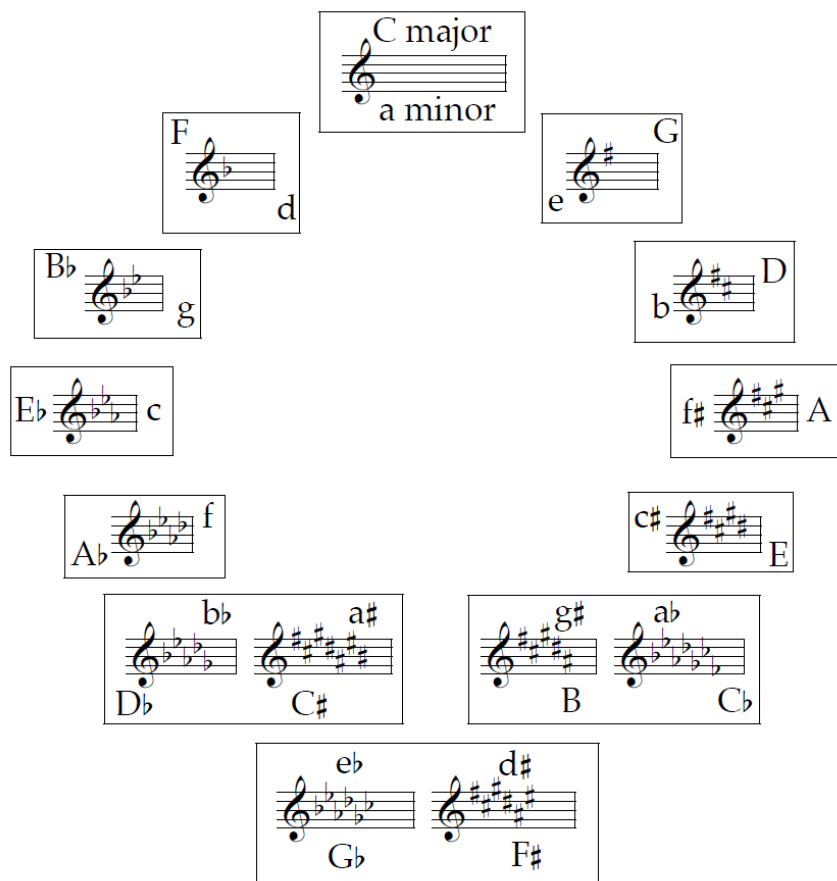

[Figure 4.5: Circle of the fifths. Minor keys are indicated with lower-case letters.]

## 5-Minor tonality

The essential difference between the major and the minor tonalities lies in the mediant degree of the scale that is used: as previously noted, the tonic-mediante interval changes its amplitude whenever either the major or the natural minor scale is considered. In the major scale it is a major third (e.g., in C major, C-E), in the minor scale it is a minor third (in A minor, A-C).

The minor tonality is one of the most interesting elements of Western music: in fact, whereas the mediant degree of the major scale coincides with the 5<sup>th</sup> harmonic of the tonic (the note E is the 5<sup>th</sup> harmonic of C), the mediant degree of the minor scale (in C minor, the note Eb) doesn't appear neither between the initial harmonics of the tonic, nor between its initial secondary harmonics.

However, in the musical practice, the minor tonalities are diffused and appreciated as well as the major tonalities: the minor triad doesn't be perceived less consonant than the major triad, it simply sounds different. In fact, let's consider the harmonics involved in the minor triad. Take e.g. the C minor tonic triad, C-Eb-G. The 3<sup>rd</sup> and the 5<sup>th</sup> harmonics of Eb are respectively Bb and G: Bb coincides with the 7<sup>th</sup> harmonic of C, and G coincides with both the 3<sup>rd</sup> harmonic of C and the 1<sup>st</sup> harmonic of G. Therefore, the introduction of Eb in the sound of C and G is sustained by the two most important harmonics of Eb after its octaves.

Moreover, looking at the C natural minor scale:

C, D, Eb, F, G, Ab, Bb, (C)

it is possible to observe that both Bb and Ab (which don't be included in the C major scale) give further emphasis to Eb: in fact, Bb is the 3<sup>rd</sup> harmonic of Eb, and Eb is the 3<sup>rd</sup> harmonic of Ab.

It is to be noted, however, that E, being the 5<sup>th</sup> harmonic of C, inevitably provides a relevant contribution to every triad whose root is C. Consequently, this harmonic may be in conflict with the presence of Eb in the C minor triad, especially when the root is doubled. This acoustic impurity, perhaps, gives to the minor mode its characteristic flavor.

A typical aspect of the minor tonalities is the usage of chromatically rising the seventh degree, or both the seventh and the sixth degrees, of the natural minor scale, so that two additional scales arise. They are the **harmonic minor scale**:

A, B, C, D, E, F, G#

and the **melodic minor scale**:

A, B, C, D, E, F#, G#

which are shown in Figure 5.1.



[Figure 5.1: The minor scales.]

Since the notes F# and G# have fewer harmonics in common with the tonic triad A-C-E than F and G, these chromatic changes mainly have melodic purposes, as it will be discussed in chapter 9. To be specific, G# assumes an "harmonic function" only in particular situations (as shown in chapter 13).

The introduction of F# and G# leads to the birth of new triads, which enlarge the collection that was found on the diatonic scale degrees in the previous chapter. In the case of the harmonic minor scale, all the triads that is possible to obtain are:

**A-C-E ; B-D-F ; C-E-G# ; D-F-A ; E-G#-B ; F-A-C ; G#-B-D**

The triads on the first and the fourth degrees are minor, the triads on the fifth and the sixth degrees are major, the triads on the second and seventh degrees are diminished, and the triad on the third degree is augmented.

In the case of the melodic minor scale, the triads are the following:

**A-C-E ; B-D-F# ; C-E-G# ; D-F#-A ; E-G#-B ; F#-A-C ; G#-B-D**

where the triads on the first and second degrees are minor, the triads on the fourth and fifth degrees are major, the triads on the sixth and seventh degrees are diminished, and the triad on the third degree is augmented.

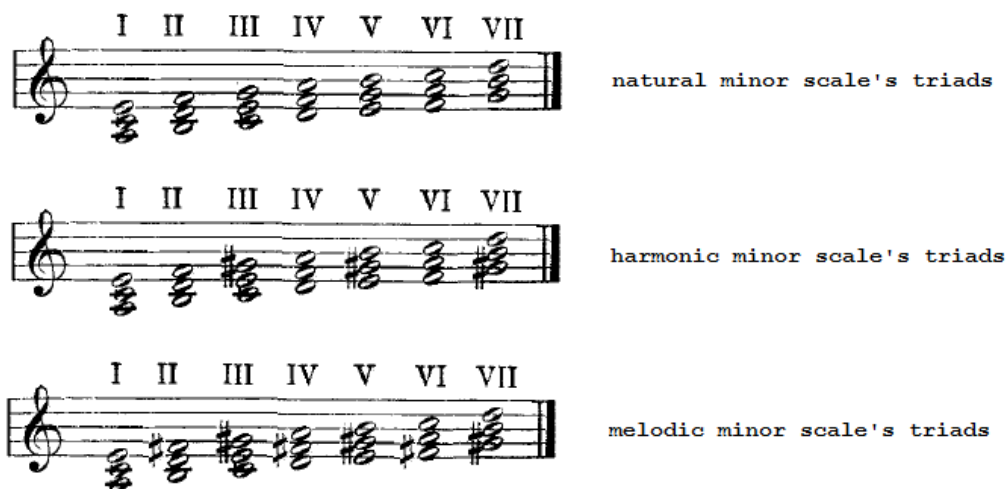

[Figure 5.2: Triads on the minor scales.]

These scales produce the augmented triad, which is absent among those obtained from the degrees of the diatonic scale. The augmented triad divides the octave in three equal parts; it will be discussed in chapter 15.

It is to be remarked that the origin of a chord from the minor key, such as the augmented triad, never obstructs its use in major keys. The membership of a chord to a scale establishes its affinity with the acoustical emanations of the tonic degree, that is, establishes its bond to the tonality: the scale to which the notes of the chord belong represents the most natural context where the chord can be adopted. The derivation from a scale reflects the affinity of the chord with the aesthetic (acoustic and/or historical) elements that are involved in the shape of the scale itself, but it never limits the artistic possibilities that the chord can supply.

## 6-Inversions of major and minor triads

As discussed in chapter 4, triads have two inversions: in the first inversion the third is placed in the bass, while in the second inversion the fifth is the lowest note. The harmonics of the bass provide a greater contribution to the chords than that of the other notes; therefore, in the case of the major and minor triads, a change in the bass alters the triad's stability and solidness: the acoustic aspects that make the root position particularly solid lose much of their influence. This is true, in particular, in the case of the major triad.

To be specific, whereas in the major and minor triads' root position the third and the fifth have numerous harmonics in common with the bass, if the bass changes then also the harmonics that have to be considered change. When the triad is inverted, the bass forms different intervals with the other two notes (in the first inversion, a third and a sixth; in the second inversion, a fourth and a sixth). As a result, the number of the harmonics that the bass has in common with the upper notes decreases.

However, since the inversion of a consonant interval produces another consonant interval, dissonances cannot arise from the inversion of a major or minor triad (except for the fourth's special behavior: as it was noted in chapter 2, the fourth with the bass produces the effect of a dissonance). Therefore, the inversions can be considered "weaker" representatives of the corresponding root positions.

The inversions of the major and minor triads have a number of useful characteristics. In fact, the lesser affinity of the new bass with the upper notes subtracts to the bass the emphasis that its lowest position would spontaneously provide. This weakening of the bass line lightens the music of the other parts. Inversions also produce variety in the chords displacement because consent to avoid the repetition of the same lowest note. Moreover, they offer many additional possibilities in the design of the voice-leading, and thus allow the composer to obtain smoother chord progressions.

In the evaluation of the acoustic properties of the inverted triad, the change in the bass implies that different harmonics have to be taken. To be specific, considering the C major triad C-E-G, the root position involves the following harmonics:

**C:** C, C, G, C, E, G, B $\flat$  ...

**E:** E, E, B, E, G $\sharp$ , B, D ...

**G:** G, G, D, G, B, D, F ...

where the bolded letters mark the harmonics that the upper notes have in common with the bass. Then, consider the first inversion:

**E:** E, E, B, E, G $\sharp$ , B, D ...

**G:** G, G, **D**, G, **B**, **D**, F ...

**C:** C, C, G, C, **E**, G, Bb ...

and the second inversion:

**G:** G, G, D, G, B, D, F ...

**C:** C, C, **G**, C, E, **G**, Bb ...

**E:** E, E, **B**, E, G#, B, **D** ...

As it can be noted, in the root position the harmonics of E and G which are shared with the bass C are closer to the beginning of their sequences than those of the inversions, and therefore they usually have greater volumes. Consequently the root position sounds slightly more consonant than its inversions.

Now, let's consider the minor triad in its root position:

**A:** A, A, E, A, C#, E, G ...

**C:** C, C, **G**, C, **E**, **G**, Bb ...

**E:** **E**, **E**, B, **E**, G#, B, D ...

Then, take its first inversion:

**C:** C, C, G, C, E, G, Bb ...

**E:** **E**, **E**, B, **E**, G#, B, D ...

**A:** A, A, **E**, A, C#, E, **G** ...

and the second inversion:

**E:** E, E, B, E, G#, B, D ...

**A:** A, A, **E**, A, C#, **E**, G ...

**C:** C, C, G, C, **E**, G, Bb ...

It can be noted that the note E is the only harmonic (except one G) that is shared among the two inversion's displacements. This harmonic strongly contributes to make consonant the root position as well as its inversions. Moreover, such remarkable presence of the harmonic E contributes to the tendency of the minor the triad to go to the dominant triad, which is a spontaneous destination of the minor triad.



## 7-Consonance and dissonance

The consonant or dissonant quality of an interval is established by the harmonics that the two notes forming the interval have in common. In particular, the initial harmonics of a note are the most significant because they are generally louder than the following ones. As noted previously, the first 8 harmonics allow to find (by looking at their relative distances) all the consonant intervals which are used in Western music.

It is possible to subdivide the consonant intervals into 2 groups:

- Those intervals lying between the fundamental frequency (or its octaves) and its first 5 harmonics. That is, the unison (the interval between the fundamental frequency and itself), the octave (the interval between the fundamental and the 2<sup>nd</sup> harmonic), the perfect fifth (the interval between the fundamental and the 3<sup>rd</sup> harmonic) and the major third (the interval between the fundamental and the 5<sup>th</sup> harmonic).
- The intervals that don't involve the fundamental, that is, the perfect fourth (the interval between the 3<sup>rd</sup> and the 4<sup>th</sup> harmonics), the minor third (the interval between the 5<sup>th</sup> and the 6<sup>th</sup> harmonics), the major sixth (the interval between the 3<sup>rd</sup> and the 5<sup>th</sup> harmonics), and the minor sixth (the interval between the 5<sup>th</sup> and the 8<sup>th</sup> harmonics).

Thus, whereas in the first group the intervals' upper note is itself one of the 5 initial harmonics of the lower note, in the second group, on the contrary, the same relationship doesn't take place. E.g., if the lower note is C, the fourth interval is C-F, the minor third is C-Eb, the major sixth is C-A, and the minor sixth is C-Ab: all their upper notes, F, Eb, A and Ab, don't belong to the initial harmonics of C.

The second group (which comprises the inversions of the intervals in the first group, plus the minor third and the major sixth) is representative of a consonant behavior which is different, and perhaps to some extent weaker, than that of the first group. In fact, the consonance of the intervals in the second group is provided by the following relationship: either the 3<sup>rd</sup> or the 5<sup>th</sup> harmonic of the upper note coincides with either the 1<sup>st</sup>, the 3<sup>rd</sup> or the 5<sup>th</sup> harmonic of the lower note. To be specific:

- In the fourth interval C-F the 3<sup>rd</sup> harmonic of F is C, which is the 1<sup>st</sup> harmonic of C.
- In the minor third interval C-Eb the 5<sup>th</sup> harmonic of Eb is G, which is the 3<sup>rd</sup> harmonic of C.
- In the major sixth interval C-A the 3<sup>rd</sup> harmonic of A is E, which is the 5<sup>th</sup> harmonic of C.
- In the minor sixth interval C-Ab the 5<sup>th</sup> harmonic of Ab is C, which is the 1<sup>st</sup> harmonic of C.

This analysis might allow to consider the intervals in the first group "tonically consonant", because their upper note coincides with one of the initial 5 harmonics of their lower note, whereas those in

the second group can be viewed as “phonically consonant”, because the harmonics that the upper note has in common with the lower note are either the 3<sup>rd</sup> or the 5<sup>th</sup>, but not the 1<sup>st</sup>.

In the case of dissonant intervals, on the other hand, neither the upper note nor its first 5 harmonics coincide with one of the first 5 harmonics of the lower note (i.e., they don't belong neither to the first group nor to the second group of consonant intervals). In fact:

- In the minor second interval (C-Db), the lower and the upper notes don't have harmonics in common (among the initial ones).
- In the major second interval (C-D), D is the 9<sup>th</sup> harmonic of C, the 7<sup>th</sup> harmonic of D is C (1<sup>st</sup> harmonic of C), and the 9<sup>th</sup> harmonic of D is E (5<sup>th</sup> harmonic of C).
- In the tritone interval (C-F#), the 7<sup>th</sup> harmonic of F# is E (5<sup>th</sup> harmonic of C).
- In the minor seventh interval (C-Bb), Bb is the 7<sup>th</sup> harmonic of C, the 5<sup>th</sup> harmonic of Bb is D (9<sup>th</sup> harmonic of C), and the 9<sup>th</sup> harmonic of Bb is C (1<sup>st</sup> harmonic of C).
- In the major seventh interval (C-B), the lower and the upper notes don't have harmonics in common (among the initial ones).

It would be useless to consider those harmonics beyond the 9<sup>th</sup>: the 10<sup>th</sup> and the 12<sup>th</sup> are respectively octaves of the 5<sup>th</sup> and the 3<sup>rd</sup> harmonics, the 11<sup>th</sup> is out of tune (being its equal tempered approximation 49¢), and the influence of the next ones, in any case, is greatly lessened by the decreasing of their volumes.

The above classification is related to the fact that, as it was discussed in chapter 4, the ear tries to consider the 2 notes of an interval as belonging to the same harmonic series: so, for example, the octave interval C3-C4 is recognized as part of the harmonic series of C3 or C2 (C in every case), and the fifth interval C3-G3 is recognized as part of the harmonic series of C2. But consider the fourth interval C3-F3: it belongs to the harmonic series of F1. In such case the ear perceives two harmonic series: the harmonic series of F and the harmonic series of C, because C is the lowest note. Two distinct harmonic series live in this interval, and the brain perceives this conflict. This explains why the fourth is to be considered less consonant than its inversion, the fifth. The same applies to the minor third, the major sixth and the minor sixth: the upper note doesn't belong to the harmonic series of the lower note.

Thus, in general, what produces the dissonance of intervals and chords is the increase of the number of different harmonic series that are involved (i.e., the presence of different roots having comparable importance) and the decrease of common harmonics between them. The simultaneous presence of different harmonic series implies additional work for the brain, and this work becomes harder as the harmonic series are “unrelated” to each other, i.e. they share a small quantity of common harmonics.

The dissonant intervals are fundamental components of Western music. Chords including dissonant intervals are called **dissonant chords** or **discords**, and the word “dissonance” can refer to both dissonant intervals and dissonant chords. Whereas the consonant chords (major and minor triads) give the melody an effect of stability, the dissonant chords are the elements that provide tension

and movement: if a dissonant chord is set under the note of a melody, this note acquires prominence and vitality, and needs to be followed by another note.

Put in other terms, the dissonant chords generate the effect of stress and accumulation of energy, so that it arises the need for some stratagem to release the energy. The consonant chords are the natural targets where the dissonance's tension is discharged and leaves the place to relaxation and stability: the appropriate transition from a dissonant chord to a consonant chord gives the listener the effect of fulfilling a necessity, it satisfies his sense of form. The listener should be guided through alternating moments of tension and relaxation, he should be continuously waiting for something to come.

## 8-Voice-leading

The musical composition begins with the choice of the number and the nature of the involved sounding elements, called the **parts** (voices and/or instruments). The intervals and the chords are entities resulting from the contemporaneous movement of the parts. Whereas the acoustical aspects that have been discussed in the previous chapters provide explanation to the pleasantness of a chord or an interval from a stationary point of view, the connections between the chords take place within the horizontal ("dynamic") dimension of the music, being originated from melodic events (the melodies of the parts). The melodic motion of each part, the **counterpoint**, is indeed a fundamental component of harmony: the transition from a chord to the next can be very unpleasant if the melodic activity of the parts is neglected.

The laws concerning the voice-leading reflect the manifestation of the melody in the horizontal relationships between the chords. Since instrumental music has fewer limitations than the writing for choir, being more emancipated from possible intonation difficulties, the rules concerning choral music surely work when writing for instruments, and hence could be considered the most general rules. In any case, many of the principles of the voice-leading apply to both voices and instruments.

So, the melodies of the parts have to be composed with the awareness of the chords resulting from their combination. Every episode in voice-leading becomes harmony, and every chord becomes the basis for voice-leading. The typical harmonic exercise requires, given the melody of one part (usually one of the outer voices), to write the melodies of the other parts.

The historical evolution of the theory of harmony has taken place in the context of the choral liturgical music, where the choir elements usually sang at sight and without the help of instruments providing reference notes or chords. As a result, the old guidelines consent to obtain complex works through the superposition of simple melodic lines.

The majority of the harmonic episodes seldom involve more than four different notes. Hence, four parts are enough for the most common harmonic operations to be described. Chords involving more than five different notes rarely occur in the music of the common practice period.

An incisive melody can often justify anomalies in the accompanying harmony. In other words, a sufficiently articulated melodic progression can bear the responsibility for strongly dissonant chords. Consequently, the most basic implementation of the principles of the voice-leading works without rhythm: it consists of displacing a bare succession of equally-spaced chords (usually whole-note or half-note chords); each note of the chords is assigned to one part, so that the melodies of all the parts consist of the repetition of the same rhythmic value. The melodies are therefore forced to change simultaneously, eventually repeating the same note. This essential layout allows to identify the most general and basic melodic connections between adjacent chords, that is, the fundamental techniques of part writing. The majority of the examples that will be given in this text follows this scheme.

The four-part chorale-style format is notated on two staves, with each staff containing two parts: soprano and alto voices on the upper staff, tenor and bass voices on the bottom staff. Soprano and tenor are written with stems up, the others with stems down. Each part is restricted in its limited range (see Figure 8.1) and the crossing between voices (one voice goes higher or lower than one of its neighboring voices) should be avoided.

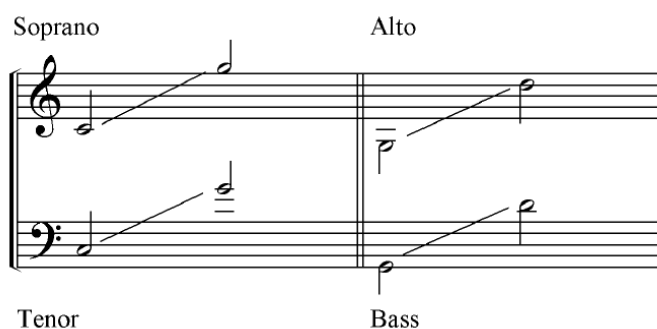

[Figure 8.1: Voice ranges in the four-part writing.]

As noted in chapter 4, the highest part's melody is perceived with greater clearness than the lower voices because of the higher pitch itself (the "surface level" of the musical perception). Therefore, it is generally to be considered the song's leading melody. Along with the higher part, also the bass is easily identified by the listener, and consequently assumes a secondary melodic function (in fact, it is sometimes indicated as the "second melody"). The highest and the lowest parts are called the **outer parts**, while the remaining ones are the **inner parts**.

As a general rule for obtaining fluent and homogeneous chords connections, the inner parts should be the most stationary as possible. They should move only if they really have to, making no more than the actions which are absolutely needed for connecting the chords. In particular, when two consecutive chords have a note in common, this note should continue to be held in the same part. The note that remains sustained during the transition from one chord to the following is called **common tone**.

Whereas common tones allow the inner parts to provide a solid harmonic link between consecutive chords, the repetition of the same note in the outer voices may require some additional melodic justifications. In any case, common tones give the composer a very powerful glue for connecting different chords: observe that when a note is stationary while the other parts change, also its harmonics continue to live. Thus, a greater number of notes actually become common tones.

For example, the tonic's triad shares two notes with both the triad on third degree and the triad on the sixth degree; and it shares one note with the triads on the fourth and on the fifth degrees. Therefore, while performing e.g. the connections I-III, I-IV, I-V and I-VI, the common tones should be sustained, as shown in Figure 8.2. The use of inversions considerably enlarges the set of the available possibilities for allowing the common tones to belong to the same part. Note that if all the notes but one remain sustained (e.g. in I-III and I-VI) then the note that changes inevitably assumes a melodic role.



[Figure 8.2: Examples of common notes tying.]

Each part should have a pleasant and non-trivial (repetitive) melody. These melodies, especially those of the inner parts, should frequently be segments of the major or minor scales, which are themselves primitive melodies. Whenever the chords are joined through conjunct (stepwise) motion of the parts, their progression is very fluent. Bad melodic lines, on the other hand, produce bad chord connections. Although a change in the harmony can alleviate the effect of the repetition of a certain melodic progression, excessive lack of variety in the melody generate dullness and doesn't sound good.

Whenever no common notes are available and the motions by scale degrees don't be practicable, each part should be careful when leaping through dissonant intervals, including all the augmented and diminished intervals. While the inner parts rarely jump more than a fifth, the outer parts are allowed to freer stunts. E.g., if the bass is a common tone, then it can jump to the octave above or below instead of being sustained. It is also advisable that a big leap will be followed by a motion in the opposite direction. Moreover, the composer should avoid two consecutive big leaps in the same direction, unless they outline a triad or they replicate the notes of the other parts. In particular, if the sum of two leaps is a dissonant interval, the ear perceives the dissonance because it detects the relationship between the initial and the final notes.

Writing triads for more than three parts requires the composer to assign the same note to two parts, in unison or at different octaves. In the case of the major and minor triads, the doubling of the root provide strength and stability to the chord. When dealing with dissonant chords, on the other hand, the duplication of the notes that take part to dissonant intervals increases the dissonance because it produces an inversion or a replica of the dissonant interval. Also, it is sometimes necessary to omit a note from a chord: in the case of the major or a minor triad, the missing note will be the fifth, because the third establishes the quality of the triad, and the root is generally tripled. Incomplete chords are rarely used in inversion.

Although it doesn't exist a rigid criterion for displacing the notes on the vertical dimension, for obtaining a balanced sound, in general, the upper three parts should be kept within an octave of

one another, while the bass can wander freely away from them. Moreover, if two parts lie close to each other, the other parts shouldn't reside too far from them. It is possible to identify two main styles that should be roughly followed: the *close position* and the *open position* (see the Figure 8.3). When a triad is written in close position, no other triad's notes can be inserted between two adjacent parts. The close position is related to a brilliant and clear sound; if a spreader displacement is used, the sound becomes soft and mellow.

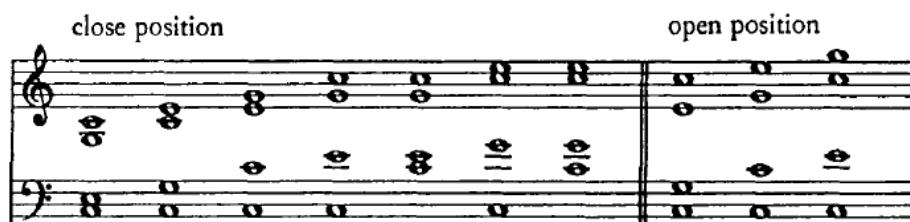

[Figure 8.3: Close position and open position.]

Since chords arise from the superposing of different and autonomous melodic layers, a very important principle of the voice-leading is to maintain the **relative independence of the parts**. That is, the voices should differentiate their relative motions. It is possible to distinguish four types of collective motion: **contrary motion**, **oblique motion**, **similar motion** and **parallel motion** (see Figure 8.4). The autonomy of the parts is obtained by using contrary and oblique motion more often than similar motion, and by using parallel motion only occasionally.



[Figure 8.4: Examples of contrary, oblique, similar, and parallel motion.]

When parallel motion is used, no more than two parts go parallel. In four part writing, parallel motion of octaves and fifths should be avoided. Such parallel motion in octaves, fifths and (to a lesser extent) fourths is adopted mostly with the aim to create sound effects in a context where a large amount of sounding elements are present. These parallel motions are primarily used for thickening the melodies and for giving them more emphasis. In the case of big ensembles, in fact, many elements will have to perform the same part: since the instruments have different ranges, the melody usually has to be pitched at different octaves depending on the instrument to which it is assigned.

The historical evolution of parallel octaves and fifths has been more or less the following: in the early times of polyphonic music, when many people had to sing a melody that was normally performed by a single voice, the melody was doubled by singing in octaves or fifths. Later, when Western music began to approach higher levels of complexity, musicians realized that parallel octaves and fifths often broke the formal homogeneity. In fact, if the harmonics are viewed as notes

that are missing in the score, the number of parts that proceed in parallel augments as the consonance of the repeated interval increases. Thus, the presence of many parallel harmonics alter the uniformity of the sound's evolution; to some extent, it cancels the independence of the parts. Parallel thirds and sixth, on the contrary, have a fewer amount of harmonics in common, and hence their parallelism doesn't be as manifest as in the case of octaves and fifths.

During the common practice period the parallel motion of dissonant intervals was avoided. Since the parallel motion of the fourths is similar to that of the fifths, what remained possible was parallel thirds and parallel sixth, which were regularly used (with moderation). In today music, where the large majority of chords are dissonant, there are no limitations to the parallelism between dissonant intervals.

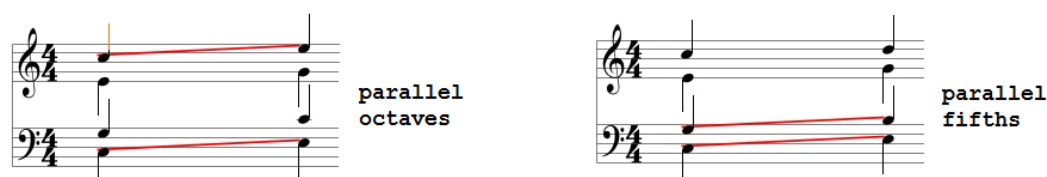

[Figure 8.5: Parallel octaves and parallel fifths.]

Avoiding parallel octaves and fifths becomes harder when connecting chords that don't have notes in common, such as the diatonic triads that are built upon adjacent degrees. Here the use of inversions, the doubling of the third and the occasional omission of the fifth help to get around this difficulty.

Whenever the dissonance is not produced through a melodic progression of the parts, that is, if the dissonance doesn't be justified by the impetus of a melody, then it is often necessary to mitigate its appearance, especially if it involves non-diatonic notes. The traditional method for smoothly introducing a dissonant interval is the following: one of the interval's two notes should appear in the previous chord too, where it forms consonant intervals with the other parts. Then this note remains held in the same part, so that when passing to the second chord it creates the dissonant interval without moving. That is, the note is a common tone. This procedure is called **preparation of the dissonance**, and the note which remains sustained is said to be *prepared*. So, if a dissonant interval involves a non-diatonic note, this note is the preferable to be prepared: its first manifestation should happen in a consonant interval or chord.

This practice was introduced also because it helps the singers: the dissonant intervals are usually difficult to sing at sight, so that putting the problematic note in the previous consonant chord makes possible to sing it when it's easy to intone. This procedure for introducing dissonances can be iterated through a progression of dissonant chords, where each chord is dissonant but incorporates the preparation of a dissonant interval in the next chord.

Since dissonances create a sense of instability, they need a target where to release the tension that they have accumulated. The definitive conclusion of a dissonant progression is called **resolution of the dissonance**, and must be a consonant chord. The dissonance is then said to be *resolved*.



Usually, when going to the chord of resolution, the prepared note moves one degree downward or (less frequently) upward, while the bass often proceeds in the opposite direction. The prepared note preferably goes (by scale step) to a note that wasn't included in the previous dissonant chord, so that the newness of the consonant interval accentuates the effect of resolution. The resolution of the dissonance can also be delayed: the prepared note remains held and takes part to intervening chords that precede the chord of the resolution.

Both the preparation and resolution of dissonances should be performed by the same part, which begins and concludes into consonant intervals, and produces a dissonance only when it doesn't move. Moreover, doubling a dissonant note in four part writing has to be avoided (also) because both that note and its replica should resolve the same way, creating parallel octaves.

As discussed in chapter 4, within any note lies the predisposition to fall a fifth below it (or to go up a fourth, which is the same), because any note can be viewed as the 3<sup>rd</sup> harmonic of the note lying a fifth below it. Accordingly, the ideal chord where the dissonance finds its resolution is the major or minor triad whose root lies a fifth below the root of the dissonant chord.

Among the four types of triad, two of them are dissonant: the diminished triad and the augmented triad. They don't include the fifth interval, which is replaced by dissonant elements: the diminished triad has the tritone, and the augmented triad has the augmented fifth (diminished fourth when inverted). When resolving these dissonances, as it will be discussed in chapter 13, the notes forming diminished intervals have the tendency to approach one another, and notes forming augmented intervals have the tendency to diverge.

In the early times of tonal music, also the fourth above the bass (appearing e.g. in the second inversion of the major and minor triads) was treated like it was a true dissonance: either the bass or the fourth was prepared, and the resolution allowed the fourth to become the root of the next consonant chord. Even if this practice became superfluous, is it advisable to keep the fourths between the upper three voices.

In the Figure 8.6 examples of treatment of the diminished triad's dissonance are shown.



[**Figure 8.6:** Examples of treating the tritone dissonant interval when appearing in the diminished triad VII of the major scale. The note F of VII is prepared and resolved.]

Figure 8.7 shows some examples of phrases where the guidelines concerning the traditional voice-leading in major tonality apply.



[Figure 8.7: Simple phrases in major key. Taken from Arnold Schoenberg's *Theory of Harmony*.]

During the common practice period, unprepared dissonances progressively became more and more frequent. When a dissonant interval is introduced without preparation, the two notes should enter by degrees, possibly by contrary motion. In fact, if the dissonance is produced through a melodic progression, such as a segment of the diatonic scale, then the melody itself becomes responsible for the appearance of the underlying dissonant interval. Figure 8.8 shows two examples where the melodies of the part allow the occurrence of unprepared dissonances.



[Figure 8.8: Unprepared dissonances: the appearance of the dissonant interval is justified by the melodic lines.]

## 9-Voice-leading in minor tonality

The guidelines that have been introduced in the previous chapter fully apply to both the major and the minor tonalities. In the case of minor tonalities, however, the harmonic and the melodic minor scales introduce new difficulties, since they include chromatically altered notes.

As shown in chapter 5, the harmonic minor scale is A, B, C, D, E, F, G#, and the melodic minor scale is A, B, C, D, E, F#, G#. These scales find their origin during the modal era, when the chromatic raising of either the seventh or both the seventh and the sixth degrees of the minor-like modes was typical, especially in the Dorian and the Aeolian modes. Such modifications happened spontaneously, being driven by the need of reaching the beginning note of the scale through an ascending motion of a half-step. Thus, the seventh degree was chromatically raised so that the leading-tone appeared in the modes that don't have it.

As it will be discussed in chapters 13 and 14, the leading-tone has the tendency to lead the melody to the above tonic. The opposite motion (from tonic to leading-tone), on the contrary, doesn't be spontaneous to the same extent. Therefore, whereas the chromatic change in the seventh degree occurs especially when the melody ascends to the tonic, when descending from the tonic the seventh degree often remains unaltered.

The chromatic raising of the sixth degree is a consequence of the change in the seventh degree: if only the seventh was raised, in the ascending motion by steps to the tonic an augmented second leap (F-G#) would appear between the unaltered sixth and the altered seventh. Moreover, the F-G# interval produces a particular "oriental" flavor: it is included in the harmonic minor scale, and in fact the harmonic minor scale is the basis of many non-Western music.

Thus, during the common practice period, the melodic minor scale was mainly used for ascending toward the tonic, and so it is also called *ascending minor scale*. Vice-versa, the natural minor scale is also called *descending minor scale* because it was often used for descending from the tonic. The presence of different roads for approaching and leaving the tonic produces the following traditional rules (given in the case of A minor), which apply to all the parts' melodies:

- If the melody takes G#, then it should ascend to A.
- When the melody takes G, it should descend to F (or it can leap).
- If the melody takes F#, then G# (and subsequently A) should follow.
- When the melody takes F, then G or E should follow (or it can leap).

These old guidelines circumvented intonation difficulties because allowed to avoid chromatic progressions in the melody: G never goes to G# and F never goes to F# (and G# never goes to G, F# never goes to F). In fact, a certain ability is necessary for well singing semitone intervals that bring to notes out of the scale (and liturgical scores were mostly performed by non-professional singers).

In general, the consecutive presence of a note and its chromatic alteration in different parts commonly sounds bad. This is called **false relation** or **cross relation**. Hence, the chords that include G# shouldn't be preceded or followed by chords that include G, and chords that include F# shouldn't be preceded or followed by chords that include F.

Although the old voice-leading forbade the use of segments of the chromatic scale, the half-steps motions in the same part actually produce very melodic results: the chromatic voice-leading, that began to be used in the nineteenth century, is based on this possibility. It will be discussed in chapter 16.

The tendency of the leading-tone to bring the melody to the above half-step is a central aspect of harmony. In the non-chromatic (traditional) voice-leading, every chromatically raised note is treated like it was the seventh or the sixth degree of a melodic minor scale: thus, a raised note should go either a semitone upward to a diatonic note (behaving like the raised seventh degree) or a tone upward to another chromatically raised note (behaving like the raised sixth degree). Vice-versa, every chromatically lowered note is considered the sixth or the seventh degree of a natural minor scale, and therefore it should go either a semitone downward to a diatonic note or a tone downward to another chromatically lowered note. By following this principle it is possible to reproduce the harmonic style of the common practice period.

In Figure 9.1 examples of voice-leading in A minor are shown.

V III VI II V II III V I IV VII III VI

I IV II V I V I III VI IV II V I

[**Figure 9.1:** Traditional (non-chromatic) voice-leading in minor key. Taken from Arnold Schoenberg's *Theory of Harmony*.]

## 10-Seventh chords

Among the chords of four notes, the seventh chords constitute a very important subset. They are obtained by placing another third above a triad, so that a seventh interval arises between the root and the additional note. Therefore, they contain the root, the third, the fifth and the (major, minor or diminished) seventh. To be specific, seven different seventh chords are possible:

- If a major third is placed upon a major triad, a **major seventh chord** is produced. E.g., C-E-G-B. It comprises one dissonant interval, the major seventh C-B.
- If a minor third is placed upon a major triad, a **dominant seventh chord** is produced. E.g., C-E-G-B $\flat$ . It comprises two dissonant intervals: the minor seventh C-B $\flat$  and the diminished fifth E-B $\flat$ .
- If a major third is placed upon a minor triad, a **minor-major seventh chord** is produced. E.g., C-E $\flat$ -G-B. It comprises two dissonant intervals: the major seventh C-B and the augmented fifth E $\flat$ -B.
- If a minor third is placed upon a minor triad, a **minor seventh chord** is produced. E.g., C-E $\flat$ -G-B $\flat$ . It comprises one dissonant interval, the minor seventh C-B $\flat$ .
- If a major third is placed upon a diminished triad, a **half-diminished seventh chord** is produced. E.g., C-E $\flat$ -G $\flat$ -B $\flat$ . It comprises two dissonant intervals: the minor seventh C-B $\flat$  and the diminished fifth C-G $\flat$ .
- If a minor third is placed upon a diminished triad, a **diminished seventh chord** (also known as **fully-diminished seventh chord**) is produced. E.g., C-E $\flat$ -G $\flat$ -B $\flat\flat$ . It comprises three dissonant intervals: the diminished seventh C-B $\flat\flat$  and two diminished fifths, C-G $\flat$  and E $\flat$ -B $\flat\flat$ .
- If a minor third is placed upon an augmented triad, an **augmented-major seventh chord** is produced. E.g., C-E-G $\sharp$ -B. It comprises two dissonant intervals: the major seventh C-B and the augmented fifth C-G $\sharp$ .



[**Figure 10.1:** The 7 seventh chords: major, minor, dominant, diminished, half-diminished, minor-major, augmented-major.]

All the seven seventh chords can be built with the notes of either the major scale or the two minor scales. The C major scale produce the following seventh chords:

- **C-E-G-B**, a major seventh chord.
- **D-F-A-C**, a minor seventh chord.
- **E-G-B-D**, a minor seventh chord.

- **F-A-C-E**, a major seventh chord.
- **G-B-D-F**, a dominant seventh chord.
- **A-C-E-G**, a minor seventh chord.
- **B-D-F-A**, a half-diminished seventh chord.

Taking the A harmonic minor scale, the presence of G# generates a minor-major seventh chord (**A-C-E-G#**), an augmented-major seventh chord (**C-E-G#-B**), a dominant seventh chord (**E-G#-B-D**) and a diminished seventh chord (**G#-B-D-F**).

Taking the A melodic minor scale, the presence of F# and G# generates a minor seventh chord (**B-D-F#-A**), a dominant seventh chord (**D-F#-A-C**), and two half-diminished seventh chords (**F#-A-C-E** and **G#-B-D-F#**).

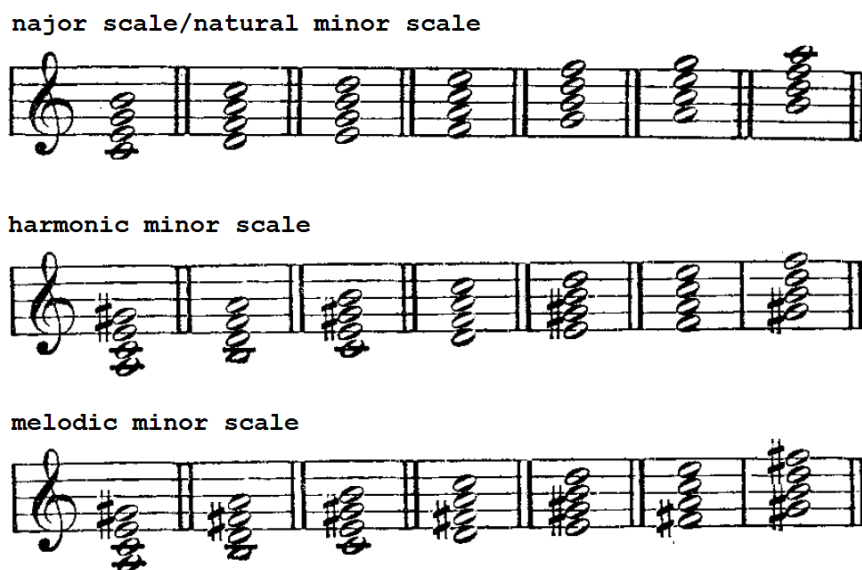

[Figure 10.2: Seventh chords on the major and the minor scales.]

When the root is the bass, the seventh chords are in root-position, as in the case of the triads. Since the seventh chords have four notes, there are three possible inversions: if the third is placed in the bass, the chord is called a *six-five chord*; when the fifth is the bass, it is called a *four-three chord*; when the seventh is the bass, a *two chord*. As in the case of the triads, these names refer to intervals which are formed with the new bass.

Among the seventh chords, the dominant seventh chord assumes a particular importance. In fact, its notes coincide with the first four new harmonics of the root, i.e. the 1<sup>st</sup>, the 3<sup>rd</sup>, the 5<sup>th</sup> and the 7<sup>th</sup> (the 2<sup>nd</sup>, the 4<sup>th</sup> and the 6<sup>th</sup> harmonics are the octaves of the 1<sup>st</sup> and the 3<sup>rd</sup>). E.g., if the root is C2, then its harmonics are:

**C2** C3 **G3** C4 **E4** G4 **Bb4** C5 ...

where the bolded letters mark the dominant seventh chord C-E-G-Bb.

The only dominant seventh chord that can be obtained from the diatonic notes lies on the dominant degree: in C major, it is G-B-D-F. If its root G is omitted, then the diminished triad B-D-F is obtained. As discussed in chapter 4, the brain perceives the omitted root G as a possible root for the chord B-D-F because B, D and F are harmonics of G. Accordingly, B-D-F and G-B-D-F “behave” in similar fashion because they share the common root G. For example, since the most natural movement of a chord is the movement toward a second chord having a root that lies a fifth below the root of the first (the root-motion of descending fifth), both these chords frequently resolve to the tonic triad (the root G goes to the root C of C-E-G in C major or C-Eb-G in C minor).

Concerning the voice-leading, the seventh chords typically resolve their dissonant seventh interval by letting the seventh to move one step downward, usually becoming the third or the fifth of the next chord. It is also frequent to keep the seventh sustained while the bass ascends. Usually, the resolution of a seventh chord into a consonant chord (or another a seventh chord) having the same bass doesn't sound good.

The earliest laws governing the part writing would also forbid the resolution of the seventh interval into the octave: i.e., a seventh whose lowest note descends a step while the upper note is sustained, or, on the contrary, the upper note ascends while the lowest note is sustained. As such exceptions began to appear in the literature, they became accepted by the theory as well.

[Figure 10.3: Preparation and resolution of the seventh chords in major key.]

Throughout the evolution of tonal music, the preparation of seventh chords' dissonances progressively became quite optional. Claudio Monteverdi is one of the firsts that freely introduced unprepared dominant seventh chords in its works. Later, Johann Sebastian Bach did the same with all the other seventh chords. Whenever the seventh is not prepared, it should be justified by the force and/or the rhythm of a melody. Since the melodies of the parts best proceed when they are portions of a major or a minor scale, the unprepared sevenths mostly appear via stepwise motion.

Figure 10.3 gives some examples of preparation and resolution of the seventh chords' dissonances in major key. In Figure 10.4 some examples in minor, and in the Figure 10.5 two phrases in minor.



V I IV III I IV VI II V IV II V VII III VI IV VII III VI II V V III VI



I IV VII II V I VII V I III VI II I VI II IV VII III II V I VII III VI

[Figure 10.4: Preparation and resolution of seventh chords in minor key.]



I VI II V I V VII III VI IV VII III VI II V I



I IV II III VI II V I IV VII III VI IV III VI II V I

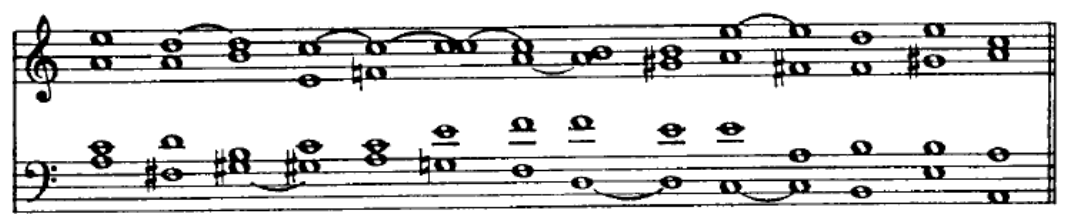

I IV VII III VI III VI II V I VI II V I

[Figure 10.5: Phrases in minor. Taken from Arnold Schoenberg's *Theory of Harmony*.]

Additional consonant or dissonant chords can be placed between the seventh chord and its resolution: in these cases, the seventh remains sustained in the same voice. It is also frequent that an inversion of the seventh chord precedes the resolution: here the seventh is taken by another voice, and resolves on a different octave.



## 11-Ninth chords

The ninth chords are made up by placing another third above the seventh chords, so that a major or minor ninth interval with the bass is produced. Thus, they have five notes: root, third, fifth, seventh and (major or minor) ninth.

The seven notes of the diatonic scale produce the following ninth chords (see also Figure 11.1):

- **C**-E-G-B-D
- **D**-F-A-C-E
- **E**-G-B-D-F
- **F**-A-C-E-G
- **G**-B-D-F-A
- **A**-C-E-G-B
- **B**-D-F-A-C

The ninth chords on the third and seventh degrees involve a minor ninth interval between the root and the ninth, the others a major ninth interval.



[Figure 11.1: Diatonic ninth chords.]

The note lying a major ninth interval above the bass coincides with the bass's 9<sup>th</sup> harmonic: consequently, the ninth chord on the dominant degree of C major, G-B-D-F-A (where the first four notes form a dominant seventh chord), comprises all the first 9 harmonics of the root G. It is also remarkable that the ninth A belongs to the harmonic series of all the notes of this chord: in fact, A is also the 7<sup>th</sup> harmonic of the third B, the 3<sup>rd</sup> harmonic of the fifth D, and the 5<sup>th</sup> harmonic of the seventh F.

If the A harmonic minor scale is considered, the following new chords arise from the presence of G#:

- **A**-C-E-G#-B
- **C**-E-G#-B-D
- **E**-G#-B-D-F

- **F-A-C-E-G#**
- **G#-B-D-F-A**

and if the melodic minor scale is considered, the following new chords appear thanks to the presence of F# and G#:

- **B-D-F#-A-C**
- **D-F#-A-C-E**
- **E-G#-B-D-F#**
- **F#-A-C-E-G#**
- **G#-B-D-F#-A**

All the seventh chords can be considered ninth chords with omitted root. In fact, all the ninth chords (if they are not written in inversion) can be viewed in two ways:

- Seventh chord + ninth
- Bass + seventh chord

E.g., the ninth chord G-B-D-F-A can be interpreted as either the dominant seventh chord G-B-D-F plus A, or the bass G plus the half-diminished seventh chord B-D-F-A.

Thus, the ninth chords offer the possibility to give each seventh chord an additional root. B-D-F-A has two roots: its own root, B, and the root G of the ninth chord G-B-D-F-A. In similar way, the diminished seventh chord B-D-F-Ab can be interpreted as the ninth chord G-B-D-F-Ab without G: accordingly, the dominant seventh chord G-B-D-F (as well as the diminished triad B-D-F within it) has many properties in common with the diminished seventh chord B-D-F-Ab. For example, their preferred destination is to resolve to the tonic triad of C major or C minor (the root-motion of descending fifth). However, whereas the perfect fifth gives the dominant seventh chord the ability to provide a sense of direction in the listener, the character of the diminished seventh chord remains ambiguous until its resolution is fully realized, as it will be discussed in chapter 15.

It is uncommon to use the inversions of the ninth chords because they sound really dissonant, though there are numbers of examples in the twentieth century's literature. Usually, they are inverted without the root, so that inversions of seventh chords are obtained.

As noted in chapter 4, the addition of a note on the top of a chord doesn't have particular influence on the behavior of the other (lower) notes because its harmonics all stay higher in the sound spectrum. Hence, the seventh chord formed by the first 4 notes of a ninth chord characterizes much of the ninth chord's dissonant behavior. In addition, like the seventh of the seventh chords, the ninth usually resolves going one step downward or remains sustained, as shown in Figure 11.2.

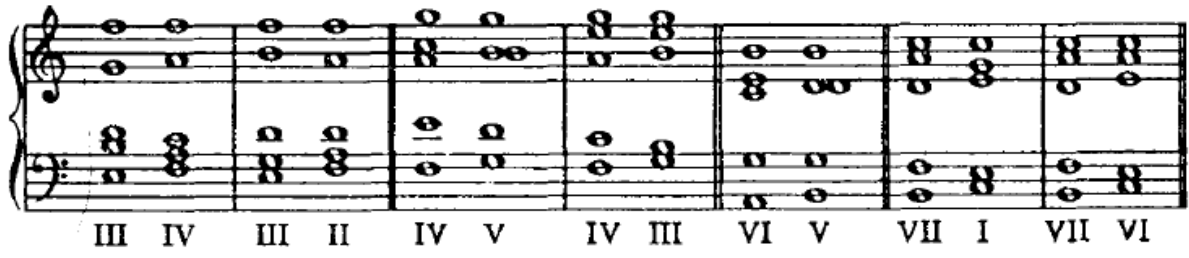

[Figure 11.2: Examples of ninth chord's resolutions.]

## 12-Embellishing notes and harmonic figuration

There often occur in music that:

- The notes of a chord don't enter simultaneously.
- The melody includes notes that form dissonant intervals with the consonant chords lying under them.

These melodic events involve notes that could be viewed as if they assumed an "ornamental" function. These notes are called **embellishing notes**, or also *non-chord tones* and *non-harmonic tones*. However, this terminology is actually incorrect, because all the notes of a melody have influence on the harmony: when some notes are listened one after the other, the brain spontaneously evaluates the relationships between them, and perceives the chord that they would generate if they were sounded simultaneously. Thus, it is hard to say whether the music arrives at chords by way of voice-leading, or the voice-leading is obtained by allowing the parts to evolve over stationary chords. At best, it is possible to identify situations where the entire responsibility for the harmony is assumed by the melodic lines.

In fact, the degree to which an interval is perceived as dissonant also depends on how well its notes are integrated into the horizontal dimension of the music, that is, it is influenced by melodic aspects. As discussed previously, the introduction of dissonant intervals can be justified through melodic means.

The historical development of the use of the dissonances is generally recognized in the writing of additional notes in the melody: musicians frequently sounded notes that were not present in the score. Subsequently, these foreign notes began to be explicitly notated. The dissonant harmonies that were produced by these melodic connections have been freed from the context, and began to be adopted as independent chords.

Notes without any influence on the future course of the harmony actually don't exist. There only exist "passing notes" that form transitory dissonant chords with the other stationary parts and/or notes that are sounded before or after the moment at which they are expected by the listener.

By looking at the classical literature, among the melodic events that may be catalogued as passing notes that form dissonances while proceeding through a stationary harmony, one can find some recurrent formulas (see also Figure 12.1):

- **Passing tone:** when a part has to make a leap of a third or a fourth interval, the passing tones occupy the remaining diatonic degrees between the interval's lower and upper notes. That is, they fill a gap between two notes a third or a fourth apart.
- **Neighbor tone:** it is a passing tone that occurs between two instances of the same note. It can also consist of two notes, making a *neighbor figure*.

- **Appoggiatura**: it is a passing note that is approached by leap and proceeds by step to the second chord. It is also called **incomplete neighbor tone**.
- **Escape tone** (or **échappée**): the opposite motion to that of the appoggiatura; that is, a passing note which is approached by step and proceeds by leap to the second chord. Also the escape tone is sometimes called "incomplete neighbor tone".

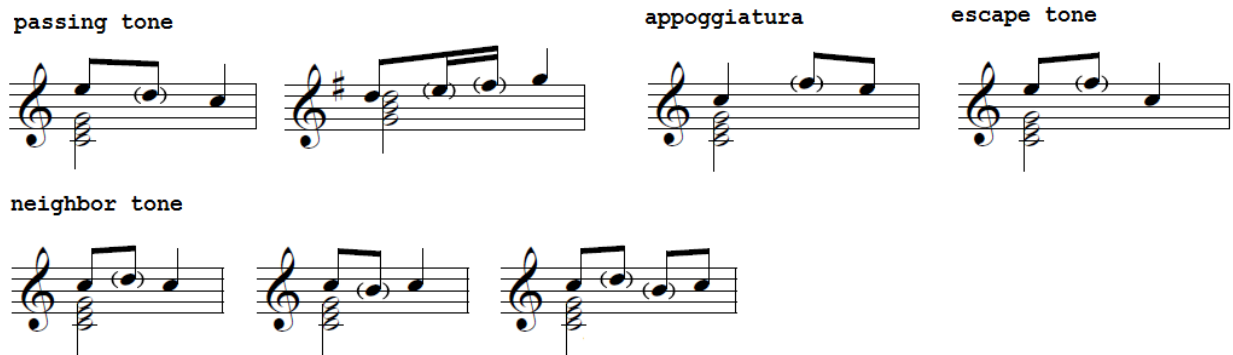

[Figure 12.1: Typical examples of passing notes.]

Among the melodic events that may be catalogued within the case of notes that enter later or that anticipate the chord to which they would belong, there are the **suspension** and the **anticipation** (shown in Figure 12.2).

Suspensions are prolongations of a note at a chord change. This note, then, moves by stepwise motion. All the other notes remain sustained, and the suspended note is the only one that moves. Suspensions generally involves the resolution of a dissonance (though it is not absolutely necessary). The dissonance is generally placed on the accented beats, while the resolution stands on a weak beat.

Suspensions most frequently resolve downward, accordingly with the typical behavior of the dissonances. The suspension upward, sometimes called *retardation*, best progresses by a half-step, and often takes place when the leading-tone ascends to the tonic. Also, preparation and resolution can be effected by different voices, eventually in different octaves; the preparation can be eventually omitted, and additional notes belonging to the suspended chord can intervene before the resolution. A suspension can involve two notes at once.

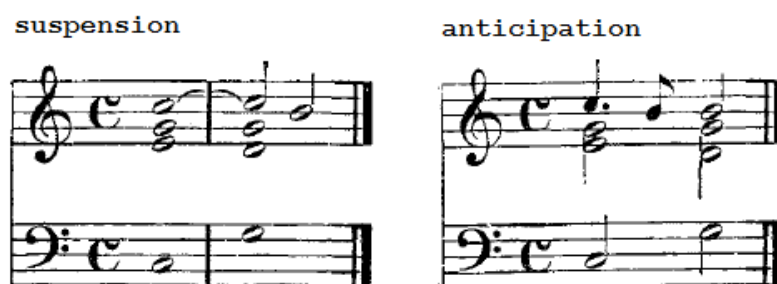

[Figure 12.2: Suspension and anticipation.]

The anticipation is basically the opposite of the suspension. It is an early arrival of a note belonging to the following chord: the note of a consonant chord is played early, producing a dissonance with the previous chord. In other words, whereas the suspension consists of one or more notes that move and form consonant intervals with the other stationary parts, the anticipation consists of one note that remains stationary while all the other notes move and form consonant intervals with it. Suspensions and anticipations can noticeably improve the movement of the parts, and can be exploited for introducing strongly dissonant chords.

As noted above, since the brain perceives the relationship between notes that are not sounded simultaneously, the classification which assumes ornamental melodic structures, the embellishment notes, is unfounded: all the notes of a piece always are to some extent bounded together. This ability of the brain to recognize the chords that are formed by non-synchronized notes can be exploited for creating the sound of a chord through the motion of only one part. That is, if all the intonation difficulties that obstacle the writing for choir are neglected, and an instrument like the piano is taken in place of the singers, it is possible to write a melody that continuously jumps between the notes of a given chord progression. Whenever the sound of a chord is exclusively produced by a sequence of consecutively sounded notes, these notes form an **arpeggio** (an example is given in Figure 12.3).

Given harmonies:

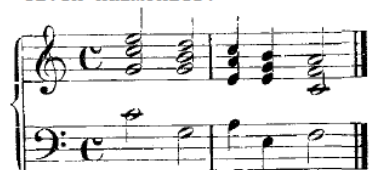

Example of arpeggio:



[Figure 12.3: A possible arpeggio of a given chord progression. Observe that the melody of the highest part is recognizable in the highest notes of the arpeggio.]

Arpeggios are examples of **harmonic figuration**, that is, the transformation of a chord progression into a more articulated movement, that involves fewer parts (perhaps only one) and smaller rhythmic divisions. Harmonic figurations occur in instrumental music, and can produce quite articulated structures.

### 13-Tendency tones and cadences

As discussed in chapter 4, the dominant degree has the tendency to go toward the tonic, and, consequently, also the dominant triad has the tendency to go to the tonic triad (the root-motion of descending fifth). So, the progression V-I (from the dominant triad to the tonic triad) provides a strong sense of conclusion. This movement corresponds to the leap a fifth below.

On the other hand, for the same reason (the dominant belongs to the harmonics of the tonic), also the opposite movement I-V, from tonic to dominant, appears quite spontaneous, but to a lesser extent than V-I. This movement corresponds to the leap a fifth above (root-motion of ascending fifth).

These root-motions of descending fifth and ascending fifth are spontaneous inclinations of every triad. Hence, the preferred destinations where a root can go are the notes lying a fifth below and a fifth above it. Thus, the roots that most spontaneously arrive to the tonic triad will be the dominant degree (a fifth above) and the subdominant degree (a fifth below): among the diatonic triads, V and IV provide the strongest connections to I. In particular, V-I is stronger than IV-I.

There is also a melodic element that makes both the progressions V-I and IV-I particularly solid. Consider the two semitones of the diatonic scale: the first semitone stays between the third and the fourth degrees, the second is between the seventh degree (the leading-tone) and the tonic. Now, it is possible to observe that:

- Since the semitone is the half of a tone, the movements of the melody through the semitones are shorter, and thus they are more spontaneous than those through the tones.
- The tonic and the third degree of the diatonic scale correspond respectively to the 1<sup>st</sup> and the 5<sup>th</sup> harmonics of the tonic, while the fourth degree and the seventh degree of the diatonic scale don't belong to the initial harmonics of the tonic.

Consequently, the seventh degree tends to move through the adjacent semitone toward the tonic, while the fourth degree tends to move through the adjacent semitone toward the third degree. The notes that behave like the diatonic scale's seventh and fourth degrees are called **tendency tones**. The leading-tone is also called **ascending tendency tone**, and the fourth degree is also called **descending tendency tone**.

So, a tendency tone is a note lying a semitone away from a second note, and spontaneously needs to be followed by this second note: this movement is also called *resolution* of the tendency tone, since it is somewhat similar to the resolution of a dissonance. E.g., in C major, the tendency tones are B and F, and they tend to move respectively toward C and E.

The resolutions of the diatonic scale's tendency tones take part to the connections V-I and IV-I. To be specific, consider e.g. C major: when connecting V (G-B-D) to I (C-E-G), B resolves to C; when connecting IV (F-A-C) to I, F resolves to E.

In the case of minor tonalities, the leading-tone (in A minor, G#) is supplied by the melodic and harmonic minor scales. Thanks to G#, the A minor's dominant triad becomes major: thus, in the progression from V (E-G#-B) to I (A-C-E), G# goes to the tonic A. The descending tendency tone of A minor coincides to that of C major (that is, F): in the connection from IV (D-F-A, a minor triad) to I, F resolves going downward to the fifth E of the tonic triad.

Observe that F is the sixth degree of the A natural minor scale: as discussed in chapter 9, the natural minor scale is especially used in descending melodic motions, while the melodic minor scale is especially used in ascending melodic motions. This is coherent with the tendency of F to move downward toward E, and the tendency of G# to move upward toward A.

Both in major and minor keys, the progression V-I from the (major) dominant triad to the tonic triad is called **authentic cadence** or **perfect cadence**. This connection is extremely solid, and the motion to the tonic triad is associated to a strong sense of conclusion, especially when the triads are in root position and the leading-tone is assigned to the highest part.

When placing an authentic cadence in the music, the minor seventh is often added to V, producing a dominant seventh chord (in C major, G-B-D-F; in A minor, E-G#-B-D). Thanks to this additional dissonant element, the cadence is reinforced by the resolution of the seventh interval. Observe that, in major key, both the tendency tones find their resolution (B goes to C, F goes to E).

Every connection to the tonic triad that involves the resolution of the leading-tone can be considered a variant of the authentic cadence. In particular, two of the possible alternatives to V-I are the following:

- VII-I, both in major and minor keys. The diminished triad VII on the leading-tone (B-D-F in C major, G#-B-D in A minor) can be obtained by omitting the root of the dominant seventh chord on the dominant degree (G-B-D-F in C major, E-G#-B-D in A minor): the omitted root can be thought as a second root for VII, so that the resolution to the tonic is a root-motion of descending fifth (from G to C in C major, from E to A in A minor). A minor seventh or a diminished seventh is often placed above VII: the minor seventh produces a half-diminished seventh chord (in C major, B-D-F-A), while the diminished seventh produces a diminished seventh chord (B-D-F-Ab). Observe that both the tendency tones find their resolution when going to the tonic triad, both in major and minor key. In minor, however, only the diminished seventh chord (in A minor, G#-B-D-F) is used in the cadence, since the half-diminished seventh chord (G#-B-D-F#) doesn't involve the descending tendency tone F.
- III-I, both in major and minor keys. In C major, E-G-B goes to C-E-G, with B that resolves to C. In minor, III is an augmented triad (in A minor, C-E-G#), with G# that resolves to A.



The transition from the subdominant triad to the tonic triad (IV-I) is called **plagal cadence**. It is a more gentle and solemn progression than the authentic cadence. Christian church hymns end with the word "Amen", which is almost always accompanied by a plagal cadence. This cadence exploits the resolution of the descending tendency tone. As noted above, in the major keys the fourth degree resolves by moving to the third of the tonic triad, whereas in the case of minor keys the sixth degree resolves to the fifth. Observe that, in minor tonalities, IV is not affected by the accidental on the sixth degree that characterizes the melodic minor scale, and therefore it remains a minor triad.

Other chord progressions that involve the resolution of the descending tendency tone into the tonic triad are possible variants of the plagal cadence. For example:

- II-I, both in major and minor keys. In C major, D-F-A connects to C-E-G; in A minor, B-D-F connects to A-C-E.
- VI-I, in minor keys only. In A minor, F-A-C connects to A-C-E.

Examples of authentic and plagal cadences are shown in Figure 13.1.

When using the authentic cadence, the subdominant triad is frequently placed before V, producing IV-V-I. This is one of the strongest chord progressions in tonal music. In minor keys, particular carefulness is needed when connecting the (minor) subdominant triad to the (major) dominant triad: an augmented second can be produced between the (unraised) sixth degree (the third of IV) and the chromatically raised seventh degree (the third of V).

Authentic cadence - major key



Authentic cadence - minor key



Plagal cadence - major key



Plagal cadence - minor key



[Figure 13.1: Authentic and plagal cadences in C major key and A minor key.]

A large amount of common practice music ends through the authentic cadence V-I. Whenever the chord following V (or VII) is not I, which is the chord the listener was expecting, the resulting cadence is called **deceptive cadence** or **irregular resolution**. Typical deceptive cadences are V-VI

and V-IV (or VII-VI and VII-IV), where V is usually found in root position. The deceptive cadence has the effect of a missing resolution, it accumulates energy instead of releasing it through the tonic triad. It can be used to prepare the authentic or plagal cadences, so that it increases their conclusive effect.

As noted above, much of the melodic power of the tendency tones is provided by the presence of a semitone between them and their resolution. Consequently, every chromatically altered note behaves like a tendency tone: chromatic raising or lowering a note means to replace a diatonic scale's note with a non-diatonic note that lies a half-step above or below it, so that a new semitone interval is created between the new altered note and the following (unaltered) diatonic note. E.g., replacing G with G# produces the new semitone interval G#-A, and replacing G with Gb produces the new semitone interval Gb-F. The altered note tends to proceed in the direction of this semitone: G# goes to A, and Gb goes to F. Thus, chromatically raised notes resolve a half-step upward, and chromatically lowered notes resolve a half-step downward.

As a consequence, the notes that form a diminished interval (where the upper note is chromatically lowered, or the lower note is chromatically raised) have the tendency to approach one another, and the notes forming augmented intervals (where the upper note is chromatically raised, or the lower note is chromatically lowered) have the opposite tendency to diverge.

## 14-Modulations

In tonal music, a modulation is the introduction of a new tonality. That is, the listener perceives the new tonic and the corresponding (major or minor) tonic triad as the most stable and conclusive sound. When a new tonality is fully adopted, usually a considerable change takes place in the music, and everything happens in the new key is emphasized. It is very common to use modulations for introducing new themes (musical phrases), or the same theme can have both a major-key version and a minor-key version. A modulation doesn't have to necessarily be a complete and permanent transition to a new key: it can be a temporary event, so that after few chords the original tonic spreads his influence again.

The transition from one tonality to another usually doesn't happen all at once. An unexpected modulation must have specific artistic purposes: whenever the notes which are typical of the new key don't be introduced in the music through a phase of transition, the change of key is generally weak and undecided. The listener has to lose the reference sounds of the tonality that he is leaving, the attraction of the old tonal center should progressively become weaker, providing the conditions for a new tonal center to be established. The preparation of the new key can include a variety of additional elements, e.g. particular rhythmical patterns that creatively bring the listener toward the new tonality.

Since the music has to gradually take the distances from the old tonic, the adoption of a new tonality (i.e. a new diatonic scale) generally becomes harder as the number of notes that have to change increases, that is, as the distance in the circle of the fifths (see chapter 4) between the old and the new keys augments. However, the bare difference between the key signatures is not the only element to be considered: e.g., the modulation between parallel tonalities is facilitated by the presence of a common dominant triad, as discussed later.

Once the influence of the old tonic has been sufficiently weakened, an energetic chord progression should establish the new tonic triad: the most incisive chord progressions to the tonic triad are the authentic and the plagal cadences, or their variants, that were discussed in previous chapter. In particular, the authentic cadence is the strongest and most used device for clearly introducing the new tonic triad. Although the use of these cadences is the standard practice, a modulation doesn't necessary have to go to the new tonic triad. When the other diatonic chords of the new tonality appear, the resulting modulation is somewhat "hidden": the new key enters without explicitly manifesting its most important element, the tonic triad.

The melodic strength of the authentic and the plagal cadences is given by the resolutions of the two tendency tones. The leading-tone (ascending tendency tone) moves to the tonic, and the diatonic scale's fourth degree (descending tendency tone) moves either to the third (in major) or to the fifth (in minor) of the tonic triad.

Looking at the circle of the fifths, the tendency tones are the notes that change when going from a major tonality to either the next or the previous one in the circle. E.g., when going from C major to

G major, a sharp on F is added: F is the descending tendency tone of C major, and the accidental produces the ascending tendency tone (F#) of G major. Going in the opposite direction, from C major to F major, a flat on B is added: B is the ascending tendency tone of C major, and the accidental produces the descending tendency tone (Bb) of F major, which is also the descending tendency tone of its relative minor (D minor).

Thus, in general, when going around the circle of the fifths in the direction where the number of sharps increases, the sharp that is added upon the descending tendency tone of a major tonality produces the ascending tendency tone (the leading-tone) of the next major tonality. Vice-versa, when going in the direction where the number of flat increases, the flat that is added upon the ascending tendency tone of a major tonality produces the descending tendency tone of the next major tonality (and its relative minor). The tendency tones drive the circular relationship: they lead from one tonality to another, being the notes that change in the transition from one key to the adjacent ones.

Remember that chromatically raised notes tend to behave like a leading-tone, and chromatically lowered notes tend to behave like the descending tendency tone. As discussed in the previous chapter, replacing a diatonic note with a chromatically altered note creates a new semitone interval between the new altered note and the subsequent (unaltered) diatonic note. This new semitone interval belongs to another diatonic scale, that is, to another key: this is the key where the altered note is a tendency tone. In particular, a chromatically raised note produces a semitone interval above it, and therefore it tends to ascend in the direction of the semitone; a chromatically lowered note produces a semitone interval below it, and therefore it tends to descend.

In other words, the chromatic modification of the diatonic scale makes it similar to the diatonic scale of another tonality. Take for example C major: if C is replaced by C#, then the resulting segment of the diatonic scale ...G, A, B, C#, D,... becomes identical to the D major scale and the D melodic minor scale. Consequently, this C# will work like the leading-tone of D major or D minor. The same applies to the chromatically lowered notes: if E is replaced by Eb, then the segment of the diatonic scale ...C, D, Eb, F, G,... becomes identical to the diatonic scale of Bb major and G minor, and Eb will work like the descending tendency tone of these tonalities.

However, of course, not all the tendency tones are chromatically altered notes in the other keys: considering a diatonic scale, the descending tendency tones of the six closest (in the circle of the fifths) major tonalities with more sharps or fewer flats don't be chromatically altered notes, and the ascending tendency tones of the 6 closest major tonalities with more flats or fewer sharps don't be chromatically altered notes.

To be specific, when e.g. in C major (A minor) tonality:

- The ascending tendency tones of the major tonalities with more sharps, i.e. G, D, A, E, B, F#, C# major keys, are chromatically raised notes. They are respectively F#, C#, G#, D#, A#, E# and B#.

- The descending tendency tones of the major tonalities with more flats, i.e. F, Bb, Eb, Ab, Db, Gb, Cb major keys, are chromatically lowered notes. They are respectively Bb, Eb, Ab, Db, Gb, Cb and Fb.
- The ascending tendency tones of the six closest major tonalities with more flats, i.e. F, Bb, Eb, Ab, Db, Gb major keys, don't be chromatically altered notes. They are respectively E, A, D, G, C, and F.
- The descending tendency tones of the six closest major tonalities with more sharps, i.e. G, D, A, E, B, F# major keys, don't be chromatically altered notes. They are respectively C, G, D, A, E and B.

In the case of minor tonalities, their descending tendency tone is the same note of the relative major (the sixth degree of the natural minor scale), and therefore the above discussion concerning the descending tendency tones fully applies to the relative minor keys. The ascending tendency tone, on the contrary, is the artificial leading-tone of the melodic and harmonic minor scales. Thus, when in C major (A minor) tonality:

- The ascending tendency tones of the minor tonalities with more sharps, i.e. E, B, F#, C#, G#, D#, A# minor keys, are chromatically raised notes. They are respectively D#, A#, E#, B#, F##, C## and G##.
- The ascending tendency tones of the minor tonalities with more flats, i.e. D, G, C, F, Bb, Eb, Ab minor keys, are respectively C#, F#, B, E, A, D, G, where the lasts don't be chromatically raised notes (but they are chromatically raised notes in their own tonalities, where a natural sign cancels the corresponding flat in the key signature).

In the music of the common practice period, a typical way for modulating to a new tonality consists of the introduction, at the end of an appropriate phase of transition, of the tendency tone of the new key that corresponds to a chromatically altered note in the old key. This tendency tone usually takes part to an authentic cadence (V-I or VII-I) that falls to the new tonic triad.

To be specific, if the authentic cadence is used, it is possible to distinguish the following cases:

- The modulation brings to a major or a minor tonality and the leading-tone of the new tonality is a chromatically altered note in the old tonality. In this case, this leading-tone can take part to the authentic cadence either as the (major) third of the dominant triad or as the root of VII.
- The modulation brings to a major tonality and the descending tendency tone of the new tonality is a chromatically altered note in the old tonality. In this case, this tendency tone can take part to the authentic cadence as the seventh of the dominant chord (the seventh above the dominant degree is the fourth degree) and resolves by going to the third of the tonic triad.
- The modulation brings to a minor tonality and the descending tendency tone of the new tonality is (the only tendency tone being) a chromatically altered note in the old tonality (e.g., when modulating from C major to C minor or F minor). In this case, this

tendency tone cannot take part to the authentic cadence as the seventh of the dominant, as it happened in the previous case (in minor keys, the seventh of the dominant doesn't be the minor scale's sixth degree), but it can participate as the minor ninth of the dominant chord, that resolves by going to the fifth of the tonic triad. However, frequently the cadence remains lacking of a chromatically altered note being a tendency tone.

For example, as shown in Figure 14.1, when modulating from C major (or A minor) to G major or G minor, the ascending tendency tone of the new keys, F#, is the third of the new key's dominant triad D-F#-A, that connects to the new tonic triad G-B-D or G-Bb-D. It is also the root of the diminished triad F#-A-C, that analogously leads to the same two tonic triads. When modulating to F major, the descending tendency tone of the new key, Bb, is the seventh of the new key's dominant triad, i.e. C-E-G-Bb, that connects to the tonic triad F-A-C. When modulating to F minor, the descending tendency tone of the new key, Db, is the minor ninth of the new key's dominant triad: C-E-G-Bb-Db, that connects to F-Ab-C.

The image contains two sets of musical notation. The left set shows a four-measure progression in C major: V (D-F-A), I (G-B-D), V (D-F-A), I (G-B-D). The right set shows a four-measure progression in C major: V (D-F-A), I (G-B-D), V (D-F-A), I (G-B-D). The right set also includes a four-measure progression in F major: V (C-E-G-Bb), I (F-A-C), V (C-E-G-Bb), I (F-A-C). The right set also includes a four-measure progression in F minor: V (C-E-G-Bb-Db), I (F-Ab-C), V (C-E-G-Bb-Db), I (F-Ab-C). The notes are written in treble and bass clefs.

Authentic cadences leading to the tonic triads of G major and G minor. The ascending tendency tone F# of the new keys is a chromatically altered note in the old key.

Authentic cadences leading to the tonic triads of F major and F minor. The descending tendency tones Bb and Db of the new keys are chromatically altered notes in the old key.

[Figure 14.1: Examples of authentic cadences that make use of the tendency tone of the new key that is a chromatically altered note in the old key.]

The major dominant triads that are used for modulating through an authentic cadence (with or without seventh, or ninth) are called **secondary dominants**, and the leading-tones that are involved are also called **secondary leading-tones**. The secondary dominants bring the music toward the (major or minor) tonality where they are dominants (in minor, artificial major dominants). In the common practice music, the majority of the modulations exploit the secondary dominants of the old key. The term "secondary dominant" is also used more broadly to indicate a generic major triad produced via chromatic alterations, even if it doesn't take part to a cadence and/or to a modulatory process.

The authentic cadence can also be produced by adopting, in place of the dominant major triad, the diminished triad on the leading-tone. The diminished triads whose root is a leading-tone are also called **leading-tone chords**. As in the case of the dominant triad, placing these triads in the old

key allows modulating to the (major or minor) tonalities where they are leading-tone chords (in minor, artificial leading-tone chords).

The seventh is usually added to the leading-tone triads. This seventh can be either the minor seventh (so that a half-diminished seventh chord is obtained) or the diminished seventh (so that a diminished seventh chord is obtained). When modulating to a major key, both the minor seventh and the diminished seventh are possible, but when modulating to a minor key, only the diminished seventh is to be used because it is the descending tendency tone. The three cases are shown in Figure 14.2.

E.g., when F#-A-C is used for modulating to G major, both E and Eb can be the seventh; when F#-A-C is used for modulating to G minor, then Eb will be the seventh because it is the descending tendency tone of G minor. In both the cases, the additional seventh goes downward to the fifth D of the tonic triad.



**[Figure 14.2:** Examples of authentic cadence involving leading-tone chords with added seventh. When modulating to a major key both the half-diminished seventh chord and the diminished seventh chord can be used. When modulating to a minor key (last example), only the diminished seventh chord has to be adopted because the seventh is the descending tendency tone.]

As noted above, although the authentic cadence works very well for reaching a tonic triad, placing an unexpected cadence in the middle of the music rarely produces good modulations. The cadence is only the final step of the transition from the old key to the new key, that is, it should be preceded by a progression of chords that weakens the tonic and introduces the typical notes of the new key. Within such progression the secondary dominants and the leading-tone chords can be used as well (i.e. not only in the final modulating cadence). For example, they can take part to a deceptive cadence (the new tonic triad doesn't appear after them), or to a weaker form of the authentic cadence, where e.g. the new tonic triad is in inversion or it includes a dissonant note.

In the case of modulations to the closest tonalities in the circle of the fifths, e.g. from C major to A minor, G major, E minor, F major and D minor, the weakening of the old tonic can be obtained through the use of the triads that the old and the new keys have in common. These triads are sometimes called *pivot chords*, and can be interpreted as belonging to both the initial and final keys.

The modulation from C major to A minor is the simplest, since the diatonic scale is the same and the two keys have all the diatonic triads in common. Whereas unprepared modulations to more distant keys usually provide abrupt and unexpected changes in the music, in the case of modulations to the relative minor (or the opposite modulation to the relative major), on the contrary, the transition is so spontaneous that the presence of an authentic cadence frequently gives enough emphasis for the modulation to be well perceived. When modulating to the relative minor, it is advisable to anticipate the change of key by introducing the chromatically raised notes of the melodic minor scale, and avoiding the diatonic triads that include the unaltered seventh degree (in major, I, III and V). Two examples of modulation from C major to the relative minor are shown in Figure 14.3.

The modulations from C major to the adjacent keys in the circle of the fifths (G major, F major, and their relative minor keys) require a bit of carefulness: the modulating cadence should be anticipated by a sequence (eventually very short) of chords that avoids the unaltered version of the only note that changes in the key signature. E.g., when modulating from C major to G major, the diatonic triads involving F (II, IV and VII of C major) shouldn't precede the final cadence, and when modulating to F major the diatonic triads involving B (III, V and VII of C major) shouldn't precede the cadence.

Moreover, when modulating from C major to E minor or to D minor, their raised seventh degree (artificial leading-tone) should appear before the cadence, but not their raised sixth degree: in fact, the unraised sixth degree is their descending tendency tone. Observe that, on the contrary, in the modulation to the relative A minor the sixth degree F can either be altered or not.

In Figure 14.3 some examples are given. Observe that when modulating to E minor and D minor two chromatically altered notes can be used for introducing the new key: the artificial leading-tone and the note that changes in the key signature (while in the case of the modulations to G and F major, only one altered note is available).

In the case of modulations between tonalities that are more distant in the circle of the fifths (the key signatures differ in more than one note), the scarcity of common notes requires to use more elaborated solutions for building the progression that precedes the final cadence. One of the possibilities is the use of intermediate keys, i.e. "passing" or "intervening" tonalities that lie between the old tonality and the new tonality also in the circle of the fifths: the whole modulation is then subdivided into two or more consecutive modulations to adjacent tonalities. E.g., for modulating from C major (or A minor) to D major or B minor, the intermediate key will be G major or E minor; for modulating from C major (or A minor) to Bb major or G minor, the intermediate key will be F major or D minor. Figure 14.4 shows examples of modulations from C major and A minor to D major.



<p>C major-A minor</p> <p>C major I II VI A minor III IV I II V I II V I</p>	<p>C major-A minor</p> <p>C major I VI II A minor III I IV V I VI II V I</p>
<p>C major-G major</p> <p>C major I VI G major IV II III VI II V I</p>	<p>C major-E minor</p> <p>C major I E minor VI II III VI II V I</p>
<p>C major-F major</p> <p>C major I VI F major II VII III II V I</p>	<p>C major-D minor</p> <p>C major I D minor II V IV II I V I</p>

[**Figure 14.3:** Examples of modulation to the relative major/minor key and to the adjacent tonalities in the circle of the fifths. The penultimate chord is a secondary dominant. Taken from Arnold Schoenberg's *Theory of Harmony*.]

When modulating to the keys that differ in three notes, e.g. from C major or A minor to A major, F# minor, Eb major and C minor, it is possible to exploit the easiness with which from a major tonality is it possible to modulate to its parallel minor tonality, and vice-versa. In fact, in minor the authentic cadence involves a major dominant triad: this triad is the same dominant triad of the parallel major key, and therefore it can be interpreted as a member of both the two tonalities. The common dominant triad allows a direct modulation between parallel tonalities. E.g., for modulating from C major to C minor, or, vice-versa, from C minor to C major, the common dominant triad G-B-D takes part to the cadence. Once the modulation from C major to C minor is done, the next modulation to the relative major Eb major it's easy. Similarly, once the modulation from A minor to A major is done, the next modulation to the relative minor F# minor is easy.

Here the sound of the dominant chord should be sustained long enough for its derivation from the old key to be forgotten; then the authentic cadence can immediately follow. Since keeping

immobile the dominant triad rarely produces good results, usually only its root (the dominant degree of both the keys) remains stationary, while the other parts proceed with suitable chords until the final whole triad. These transitional chords can be dissonant with the sustained dominant.

C major-G major-D major

C major	I	III							
G major		VI	VII	I	VI				
D major					II	V	I		

A minor-E minor-D major

A minor	I	I							
E minor		IV	V	I	I				
D major					II	VII	VI	IV	III
								V	I

[Figure 14.4: Modulation through intermediate keys. Taken from Arnold Schoenberg's *Theory of Harmony*.]

The bridge that is created by the parallel tonalities also allows to proceed further to the keys that differ in four notes. E.g., for modulating from C major to E major it is possible to transit through A minor and A major, the last being adjacent to E major in the circle of the fifths.

The modulations that have been discussed make use of the most traditional methods of the harmony and the counterpoint of the common practice period. When these strategies are adopted for modulating to distant keys, however, the length of the transition between the initial and the final key may be considerable.



C major I IV II VII

A minor VI IV II V V

A major V V I VI II I V I

[**Figure 14.5:** Example of modulation from C major, to A minor, then to A major. The dominant triad E-G#-B of the parallel keys A minor and A major is used for modulating from the first to the second (third and fourth measures). Taken from Arnold Schoenberg's *Theory of Harmony*.]

## 15-Diminished seventh chord and augmented triad

The writing of a diatonic note using additional accidentals (e.g., in C major, E# in place of F) and the writing of a chromatically altered note using a different accidental (e.g., in A major, Gb in place of F#) is called **enharmonic change** or **enharmonic reinterpretation**. When a tonal piece includes a chord that belongs to a key that is different from the one that is adopted, the enharmonic changes consent to make explicit the chord's nature. For example, when modulating from C major to F# minor, F should be written as E# because it is the leading-tone of the new key. The sharp indicates that F stops being the descending tendency tone of C major: instead of resolving to E, it goes to the new tonic F#. That is, it becomes the ascending tendency tone of F# minor, and resolves in the opposite direction. Thus, such use of a different notation indicates the membership of a chord to a different tonal center, and informs the reader that the melody of the parts is following the profile of a different scale.

Among the chords that are most often used for modulating, and therefore that are most often enharmonically rewritten, the diminished seventh chord and the augmented triad are very important elements. Observe that their structure is very special: the diminished seventh chord is made up by joining three minor thirds together, and the augmented triad is made up by joining two major thirds. Consequently, the diminished seventh chord divides the octave in four equal parts (the sum of four minor thirds is equal to 12 semitones), and the augmented triad divides the octave in three equal parts (the sum of three major thirds is equal to 12 semitones as well).

E.g., consider the diminished seventh chord B-D-F-Ab. All its notes lie a minor third distant one from each other, and if another minor third was placed above Ab, Cb would be obtained: through enharmonic change, Cb can be written as another B. Similarly, by adding a major third on the top of the augmented triad C-E-G#, B# is obtained, which can be rewritten as another C.

As a result of these singular facts, each of the inversions of a diminished seventh chord is another diminished seventh chord, and each of the inversions of an augmented triad is another augmented triad. Therefore, by exploiting all the 12 semitones of the octave, it is possible to write only three different diminished seventh chords, and only four different augmented triads (shown in Figure 15.1). To be specific, taking e.g. the first three degrees of the chromatic scale, C, C# and D, all the available diminished seventh chords are the following:

- C-Eb-Gb-Bbb
- C#-E-G-Bb
- D-F-Ab-Cb

All the other diminished seventh chords which are built on the remaining chromatic scale's degrees coincide with the inversions of one of the above three (by enharmonic changing some notes).

Similarly, taking the first four degrees of the chromatic scale, all the available augmented triads are:

- C-E-G#
- Db-F-A
- D-F#-A#
- Eb-G-B

and those which are built on the remaining degrees coincide with the inversions of one of the above ones (by enharmonic changing some notes).

Because of the symmetric nature of the augmented triad and the diminished seventh chord, their root loses all its most important attributes. In fact, whenever the bass is changed, the amount of harmonics that the upper notes have in common with it remains exactly the same.



[Figure 15.1: The three diminished seventh chords and the four augmented triads.]

The diminished seventh chord is most naturally derived as the seventh chord on the seventh degree of the harmonic minor scale (see chapter 10). But the enharmonic change of its notes allows to consider it member of many minor tonalities. E.g., the diminished seventh chord G#-B-D-F can be written as:

- G#-B-D-F: it belongs to A minor.
- G#-B-D-E#: it belongs to F# minor.
- G#-B-C##-E#: it belongs to D# minor.
- Ab-B-D-F: it belongs to C minor.
- Ab-Cb-D-F: it belongs to Eb minor.
- Ab-Cb-Ebb-F: it belongs to Gb minor.

Moreover, one diminished seventh chord can be interpreted as four different ninth chords without root. In fact, four different basses (roots) can be respectively assigned to its root position and to the three inversions, producing four different ninth chords. To be specific, taking e.g. the diminished seventh chord F#-A-C-Eb, the following ninth chords can be produced:

- **D**-F#-A-C-Eb
- **F**-A-C-Eb-Gb
- **Ab**-C-Eb-Gb-Bbb
- **B**-D#-F#-A-C

where some notes of the diminished seventh chord have been enharmonically changed to preserve the nature of the ninth chords' intervals. Observe that the four basses D, F, Ab and B are the members of another diminished seventh chord.

Hence, since each note of the diminished seventh chord can be the root, and since one diminished seventh chord can be viewed as four different ninth chords without root, at least 8 different roots can be assigned to the same diminished seventh chord. To each root corresponds a natural resolution through the root-motion of descending fifth. So, this chord can play the role of dominant or secondary dominant in many tonalities, and can be exploited for introducing chords belonging to distant keys, as it will be discussed in the next chapter.

Analogous considerations allow to see also the augmented triad from at least three different tonalities:

- C-E-G#: it belongs to A minor.
- B#-E-G#: it belongs to C# minor.
- C-E-Ab: it belongs to F minor.

Observe that the fifths of the above triads, G#, B# and E (which, in F minor, is written by placing a natural sign), all are chromatically raised tones.

## 16-Chromatic harmony

The establishment of the tonality in a piece of music arises from the use of one diatonic scale, that is, a set of pitches having a relationship with the harmonic series of the tonic. As discussed in chapter 14, the behavior of the chromatically altered notes in a tonal piece is related to their role of tendency tones in a different tonality. If a diatonic scale's note is replaced by its chromatic alteration, then a new semitone interval is produced beside it: the altered note acquires the tendency to proceed in the direction of the new-born semitone toward the adjacent diatonic note. This modification of the diatonic scale makes it similar to one of its transpositions, that is, to the diatonic scale of another tonality: the chromatically altered note works like a tendency tone of this tonality. So, the presence of chromatically altered notes allows a tonal piece to incorporate the colors of other tonalities.

It is therefore useful to distinguish between the chords that can be obtained exclusively from the notes of the diatonic scale that is used, called **diatonic chords**, and the chords that derive from chromatic alterations of the diatonic pitches, called non-diatonic chords or **chromatic chords**. Much of the most widespread chromatic chords are diatonic chords that are used in the "wrong" key. When in minor keys, if the only notes of a chord to be chromatically altered are the sixth degree and/or the seventh degree of the melodic/harmonic minor scale, such chord is to be considered diatonic, since these alterations are distinctive elements of the sound of the minor tonality itself.

Given a chord that is diatonic in some key, it follows from the above definition that, when the tonality is not clearly established, it is impossible to say whether such chord is diatonic or chromatic. This happens, for example, when modulating: during the transition from the old to the new key a chord can be diatonic in the old key and chromatic in the new key, or vice-versa.

The term **chromatic harmony** refers to the presence of many tonal centers. This circumstance prevents the chords from having a strong relationship with one particular tonality. The possibility for a chord to be put in relation with many different keys strongly depends on two factors:

- The strength of the tonal center. Whenever more than one harmonic series simultaneously assume a leading role, i.e. they have comparable vigor, the equilibrium can be broken by very small changes.
- The nature of the chord itself: whenever many roots can be found in the sound of a chord, such chord will have a noticeable natural predisposition to be adopted in many different keys. The presence of many roots authenticates its ability to lead the music toward sonorities that are typical of different keys.

As noted in the previous chapters, the melodic motion of the parts has a great influence on the harmony. Therefore, the use of chords that don't be recognizable as elements of the same key strongly depends on the possibility of connecting them together. For such connections to be smooth and pleasant, their notes have to move mostly by semitones and tones. In particular, the

half-step motions allow the parts to melodically go from a diatonic note to the adjacent non-diatonic note. That is, the involved chromatically altered notes have to be approached and quitted mostly through half-step motions, coherently with their propensity to behave as tendency tones.

Thus, the emancipation of a chord from its home tonality is significantly related to the possibility of connecting it to chords belonging to different keys by means of **chromatic voice-leading**: diatonic notes have to be followed by their chromatic alterations in the same part, and the chromatic alterations have to resolve as tendency tones (in the same part). In other words, the melodic impetus of the half-step motions becomes responsible for the changes in the harmony.

The use of chromatic voice-leading can be thought as a consequence of the adoption of the chromatic scale as a basis for the harmony. Whereas in the common practice's voice-leading the motion of the parts proceeds through segments of either the diatonic scale or the melodic minor scale, the chromatic voice-leading allows the parts to move from each chromatic scale's degree to the adjacent ones.

The chromatic scale provides the full set of tendency tones. Coherently with the tonal behavior of the altered notes, the ascending form of the chromatic scale is written using sharps, the descending form uses flats. Chromatic voice-leading makes use of segments of the ascending/descending chromatic scale every time is possible. If two consecutive chords respectively include a note and its chromatic alteration, then the same part should move from the unaltered to the altered note: if it doesn't happen, the consecutive presence of the unaltered note and the altered note in different parts creates a false relation (see chapter 9). False relations should be avoided; however, when both the accidentals are allowable, this rule can sometimes be neglected.

Because of the simultaneous presence of many different tonal centers, the ear is ready to give the notes different harmonic meanings: the "function" of a note within the harmony is revealed by its following behavior. E.g., if the diminished seventh chord  $G\#-B-D-F$  progresses to the dominant triad  $G-B-D$ ,  $G\#$  can be replaced by  $A\flat$  because it moves a half-step downward to  $G$ . In this case, the diminished seventh chord that is used doesn't be the seventh chord built on the leading-tone  $G\#$  of  $A$  minor, but it is the seventh chord  $B-D-F-A\flat$  whose root is the leading-tone  $B$  of  $C$  minor. Thus, the enharmonic rewriting of the notes can help to show both the proper resolution of the tendency tones and the nature of the chords that appear in a context where they can be associated to more than one key. Also the augmented triad is frequently subjected to enharmonic changes: e.g., consider the augmented triad  $C-E-G\#$ , III of  $A$  minor. If  $G\#$  is enharmonically changed to  $A\flat$ , then the major third interval  $E-G\#$  becomes the diminished fourth  $E-A\flat$ . Now, since the inversion of  $E-A\flat$  is the augmented fifth  $A\flat-E$ , the enharmonic change indicates a change of root:  $C-E-G\#$  is transformed into the first inversion of the augmented triad  $A\flat-C-E$ , whose root is  $A\flat$  and it belongs to  $F$  minor.





[Figure 16.1: Examples of the use of the diminished seventh chord.]

There are some chords that have acquired particular importance in the music that followed the common practice period. The term **Neapolitan sixth** refers to the non-diatonic major triad that is built on the flat second degree of a major or minor scale: in C major and C minor it is Db-F-Ab. This chord is usually found in first inversion and, in 4-part writing, the third is commonly doubled, especially in major key, where it is the only unaltered note (the doubling of chromatically altered notes produces parallel octaves when both resolve by half-step). Its origin might be related to the Phrygian mode, where a semitone lies between the first and the second degrees.

In major keys, the Neapolitan sixth can be used as a substitute for the supertonic or subdominant degrees (the doubling of F favors this role). It is often followed by the dominant triad or by a chord that proceeds immediately to the dominant triad. When directly connected to V, Db moves to D or B, Ab resolves to G, while F ascends to G (or remains sustained to become the seventh of the dominant seventh chord). The awkward diminished third leap from Db to B in the voice-leading explains the frequent introduction of intermediate chords between the Neapolitan and the dominant. This unmelodic gap is frequently avoided through the use of a chromatic passing tone (C) between the two notes.

In minor keys, only one accidental is required to write the Neapolitan sixth chord. E.g., in A minor it is Bb-D-F. Observe that Bb-D-F is the only consonant triad where the root is a chromatically altered note while the third and the fifth belong to the C diatonic scale.

The **augmented sixth chords** are three dissonant chords that belong to both a major key and its parallel minor. They include the augmented sixth interval between the descending tendency tone (sixth degree) of the minor tonality and the chromatically raised fourth degree. In C major and C minor, this interval is Ab-F#, and the three augmented sixth chords are:

- The **German sixth**, or **augmented sixth-five chord**, Ab-C-Eb-F#. It is the use of the dominant seventh chord as chromatic chord (writing F# as Gb produces a dominant seventh chord). When Eb is written as D#, this chord is sometimes called **Swiss augmented sixth chord**.
- The **French sixth**, or **augmented six-four-three chord**, Ab-C-D-F#. This chord is made up by two major thirds separated by a tone interval. It has two roots: Ab and D. In fact, the second inversion D-F#-Ab-C is another French sixth whose root lies a tritone upward or downward.

Because of its symmetric nature, there exist only six different French sixths: C-E-F#-A#, C#-F-G-B, D-F#-Ab-C, Eb-G-A-C#, E-G#-Bb-D, F-A-B-D#.

- The **Italian sixth**, Ab-C-F#. It is a French sixth without D or a German sixth without Eb. In four-part writing, C is usually doubled.

In Figure 16.2 the augmented sixth interval and the augmented sixth chords are shown.



[Figure 16.2: Augmented sixth chords.]

All the three augmented sixth chords spontaneously resolve into the dominant triad G-B-D of C major and C minor, that is, can be used as secondary dominants leading to G though the authentic cadence, as discussed in chapters 13 and 14. In other words, they all admit D as their root (the French sixth comprises it explicitly), and can be used as leading-tone chords (F# in the bass).

From an historical point of view, the two chromatically altered tones Ab and F# were first employed separately as passing tones to the dominant degree of the scale. Then, these passing notes have been incorporated in the supertonic and the subdominant diatonic triads, that become respectively a major triad (D-F#-A) and a minor triad (F-Ab-C). Such chords were initially employed separately, but subsequently their qualities have been used together in a contrapuntal texture, producing chords that involve the augmented sixth interval Ab-F#, which allows to emphasize the dominant degree through a double-resolution from below (F# to G) and from above (Ab to G), as shown in Figure 16.3. This particular form of resolving to a perfect octave in contrary motion was a typical practice in the 17<sup>th</sup> and 18<sup>th</sup> centuries, and it provides a strong reinforcement of the dominant, regardless whether it belongs to a major or a minor tonality.

J.S. Bach, *Minuet in C minor*



[Figure 16.3: Bach's example of resolution of the augmented sixth interval Ab-F# into the dominant degree.]

Starting from the augmented sixth interval  $A\flat-F\sharp$ , the first augmented sixth chord occurs when the tonic  $C$  is added to it, to produce the Italian sixth  $A\flat-C-F\sharp$ . This chord could also be thought as the result of combining the sonorities of the diminished triad  $F\sharp-A-C$  and the subdominant minor triad  $F-A\flat-C$ . When it is followed by the dominant triad, all three notes move by half-step:  $A\flat$  goes to  $G$ ,  $C$  to  $B$  and  $F\sharp$  to  $G$ . When the chord is used in four-parts,  $C$  is usually doubled and resolves in the opposite direction of each other: one goes upward to the dominant's fifth while the other one resolves downward to the third.

The German sixth and the French sixth are obtained by adding a note (respectively  $E\flat$  and  $D$ ) to the Italian sixth. In particular:

- When the German sixth progresses to the dominant triad, all four notes move by half-step:  $A\flat$  goes to  $G$ ,  $C$  to  $B$ ,  $E\flat$  to  $D$  and  $F\sharp$  to  $G$ . However, the simultaneous resolution of  $E\flat$  and  $A\flat$  creates parallel fourths/fifths: even though the parallel fourths are acceptable, they can be disguised in various ways, e.g. by avoiding to place both  $E\flat$  and  $A\flat$  in the outer voices, by introducing passing notes, or by omitting the fifth of the dominant.
- The French sixth  $A\flat-C-D-F\sharp$  can be thought as the result of combining the sonorities of the dominant seventh chord  $D-F\sharp-A-C$  and the half-diminished seventh chord  $D-F-A\flat-C$ : both these chords resolve to the dominant triad through the root-motion of descending fifth. When the French sixth progresses to the dominant triad,  $D$  is a common tone and three notes move by half-step:  $A\flat$  goes to  $G$ ,  $C$  to  $B$  and  $F\sharp$  to  $G$ .

Figure 16.4 shows the Neapolitan sixth and the augmented sixth chords resolving into the dominant triad.

The figure displays four musical examples in a two-staff system (treble and bass clefs). Each example shows a chord progression from a sixth chord to a dominant triad. The chords are labeled below the staves: Neapolitan sixth, German sixth, French sixth, and Italian sixth. The Neapolitan sixth is shown in F major, the German sixth in C minor, and both the French and Italian sixths in C minor. The resolution of each chord to the dominant triad is clearly marked with arrows and note stems.

[Figure 16.4: Neapolitan sixth and augmented sixth chords connecting to the dominant triad.]

Both the Neapolitan sixth and the augmented sixth chords involve the descending tendency tone  $A\flat$  of  $C$  minor. In common-practice tonal music, chord progressions to the dominant incorporating a descending half-step motion from  $A\flat$  to  $G$  in the bass are sometimes grouped under the term *Phrygian Cadence*, because in the Phrygian mode a semitone separates the dominant and the submediant degrees. The French and Italian sixth chords are frequently used to obtain this effect,

while the Neapolitan sixth, on the contrary, easily produces harsh progressions when employed in second inversion and connected to the dominant.

Observe that the augmented sixth chords can be obtained from the chromatic raising of the second degree of the diatonic scale: in A minor and A major, the Italian sixth is F-A-D#, the German sixth is F-A-C-D#, and the French sixth F-A-B-D#. Moreover, writing the German sixth as F-A-C-Eb, it becomes a secondary dominant seventh chord leading to the Neapolitan sixth Bb-D-F (in C major and C minor, the Ab dominant seventh chord resolves to Db major triad).

Further dissonant chords are produced by adding a minor seventh to the augmented triad, e.g. C-E-G#-Bb, or both a minor seventh and a minor or major ninth: C-E-G#-Bb-Db and C-E-G#-Bb-D. If the root is omitted in the last, the chord E-G#-Bb-Db is obtained: it comprises a major third, a diminished fifth and a diminished seventh.

Whereas chromatic harmonies were an occasional occurrence in the music of Johann Sebastian Bach, Joseph Haydn, and Wolfgang Amadeus Mozart, their use progressively increased during the romantic period, and became an outstanding aspect of the next development of the harmony. The opera *Tristan und Isolde* (1857-59) by Richard Wagner is one of the first notable examples of massive use of chromaticism. The first chord appearing in the Prelude of the opera is known as *Tristan Chord* (see Figure 16.5): it is a half-diminished seventh chord that becomes a French sixth when G# goes to A. Then the dissonance is followed by another dissonant chord, and it is impossible to say whether the passage is in A minor or A major key. The lack of consonant chords and the permanent tonal instability produces a musical fluid that flows continuously, expressing restlessness and unrequited passion through a sort of harmonic "suspense". The music smoothly proceeds without disclosing the underlying tonal attractions, without releasing the continuous tension of the dissonances by means of the stability of consonant triads. The use of the dissonance in Wagner's opera is noticeably abnormal for its time, and played a significant role in the development of the harmony in the late nineteenth century.



[**Figure 16.5:** Richard Wagner, *Tristan und Isolde* (1857-9); bars 1-3. The asterisk marks the so-called "Tristan Chord".]

The first system of musical notation consists of two staves (treble and bass clef) with a key signature of one flat. It contains seven measures of music, each with a chord. The chords are: diminished seventh chord, French sixth, diminished seventh chord, German sixth, Augmented triad, French sixth, and German sixth.

diminished seventh chord    French sixth    diminished seventh chord    German sixth    Augmented triad    French sixth    German sixth  
 Augmented triad

The second system of musical notation consists of two staves (treble and bass clef) with a key signature of one flat. It contains seven measures of music, each with a chord. The chords are: diminished seventh chord, Neapolitan sixth, diminished seventh chord, Neapolitan sixth, German sixth, German sixth, and German sixth.

diminished seventh chord    Neapolitan sixth    diminished seventh chord    Neapolitan sixth    German sixth    German sixth    German sixth

The third system of musical notation consists of two staves (treble and bass clef) with a key signature of one flat. It contains six measures of music, each with a chord. The chords are: Augmented triad, German sixth, Augmented triad, German sixth, Augmented triad, and German sixth.

Augmented triad    German sixth    Augmented triad    German sixth    Augmented triad    German sixth

[Figure 16.6: Examples of chromatic chords. The scores have been taken from Arnold Schoenberg's *Theory of Harmony*.]

## Bibliography

- Dahlhaus, Carl, "Harmony", *The New Grove Dictionary of Music and Musicians*, vol 8, Macmillan Publishers Limited, London, 1980, pp. 175-188.
- Emery, Stephen A., *Elements of Harmony*, The Arthur P. Schmidt & Co., Boston, 1890.
- Helmholtz, Hermann L. F., *Sensations of Tone*, transl. Alexander J. Hellis, Longmans, Green, & Co., London, 1875.
- Honingh, Aline, *The Origin and Well-Formedness of Tonal Pitch Structures*, ILLC Dissertation Series DS-2006-05.
- Huron, David, *On the Role of Embellishment Tones in the Perceptual Segregation of Concurrent Musical Parts*, *Empirical Musicology Review*, Vol. 2, No. 4, 2007.
- Prout, Ebenezer, *Harmony: Its theory and practice*, Augener & Co., London, 1889.
- Rameau, Jean-Philippe, *Traité de l'harmonie réduite à ses principes naturels*, Paris: Ballard, 1722, translated as *Treatise on Harmony*, transl. Philip Gossett, New York: Dover Publications, 1971;
- Schoenberg, Arnold, *Theory of Harmony*, transl. Roy E. Carter, University of California Press, Berkeley and Los Angeles, 1978.
- Schoenberg, Arnold, *Structural Functions of Harmony*, W. W. Norton and Company Inc., New York, 1954.
- Tchaikovsky, P.I, *Guide to the practical study of harmony*, transl. Emil Krall and James Liebling, P. Jurgenson, 1900.